

ARTICLE 4

CHAPTER 1 DEFINITIONS

SEC 4.101 **CONSTRUCTION OF LANGUAGE:** For the purposes of this Resolution, terms or words shall be interpreted as follows: Words used in the singular shall include the plural, and the plural the singular; words used in the present tense shall include the future tense; the word "shall" is mandatory and not discretionary; the word "may" is permissive; the phrase "used for" shall include the phrases "arranged for," "designed for," "intended for," "maintained for," and "occupied for"; the word "person" includes a firm, association, organization, partnership, trust, company, or corporation as well as an individual; and the word "dwelling" includes the word "residence."

SEC 4.102 **TERMS NOT DEFINED:** Terms not defined herein shall have their customary meanings as found in the most recent editions of published dictionaries, including the Webster's New World Dictionary and the American Heritage Dictionary.

SEC 4.103 **DEFINITIONS:** (Presented as follows in alphabetical order).

Access Management: The process and action of providing for, and managing access to, and from land by vehicles typically associated with the use location, while preserving and promoting movement of traffic to be as safe and effective as possible, per the Access Management Regulations of Warren County, Ohio.

Accessory Building: A subordinate building, detached from, but located on, the same property as the principal building, the use of which is incidental to that of the principal building or use.

Accessory Use: A subordinate use to the principal use of the premises.

Adult Arcade: "Adult arcade" means any place to which the public is permitted or invited in which coin-operated, slug-operated, or electronically, electrically, or mechanically controlled still or motion picture machines, projectors, or other image-producing devices are regularly maintained to show images to five or fewer persons per machine at any one time, and in which the images so displayed are distinguished or characterized by their emphasis upon matter exhibiting or describing specified sexual activities or specified anatomical areas.

Adult Bookstore, Adult Novelty or Adult Video Store:

(A) Means a commercial establishment that, for any form of consideration, has as a significant or substantial portion of its stock-in-trade in, derives a significant or substantial portion of its revenues from, devotes a significant or substantial portion of its interior business or advertising to, or maintains a substantial section of its sales or display space for the sale or rental of any of the following:

- (i) Books, magazines, periodicals, or other printed matter, or photographs, films, motion pictures, video cassettes, compact discs, slides, or other visual representations, that are characterized by their emphasis upon the exhibition or description of specified sexual activities or specified anatomical areas;
- (ii) Instruments, devices, or paraphernalia that are designed for use or marketed primarily for stimulation of human genital organs or for sadomasochistic use or abuse of self or others.

(B) "Adult bookstore," "adult novelty store," or "adult video store" includes a commercial establishment as defined in section 2907.38 of the Revised Code. An establishment may have other principal business purposes that do not involve the offering for sale, rental, or viewing of materials exhibiting or describing specified sexual activities or specified anatomical areas and still be categorized as an adult bookstore, adult novelty store, or adult video store. The existence of other principal business purposes does not exempt an establishment from being categorized as an adult

bookstore, adult novelty store, or adult video store so long as one of its principal business purposes is offering for sale or rental, for some form of consideration, such materials that exhibit or describe specified sexual activities or specified anatomical areas.

Adult Cabaret: “Adult cabaret” means a nightclub, bar, juice bar, restaurant, bottle club, or similar commercial establishment, whether or not alcoholic beverages are served, that regularly features any of the following:

- (a) Persons who appear in a state of nudity or semi nudity;
- (b) Live performances that are characterized by the exposure of specified anatomical areas or specified sexual activities;
- (c) Films, motion pictures, video cassettes, slides, or other photographic reproductions that are distinguished or characterized by their emphasis upon the exhibition or description of specified sexual activities or specified anatomical areas.

Adult entertainment: Means the sale, rental, or exhibition, for any form of consideration, of books, films, video cassettes, magazines, periodicals, or live performances that are characterized by an emphasis on the exposure or display of specified anatomical areas or specified sexual activity.

Adult entertainment establishment: Means an adult arcade, adult bookstore, adult novelty store, adult video store, adult cabaret, adult motion picture theater, adult theater, nude or semi-nude model studio, or sexual encounter establishment. An establishment in which a medical practitioner, psychologist, psychiatrist, or similar professional person licensed by the state engages in medically approved and recognized therapy, including, but not limited to, massage therapy, as regulated pursuant to section 4731.15 of the Revised Code, is not an “adult entertainment establishment.”

Adult group home: ORC 3722.01 means a residence or facility that provides accommodations to six (6) to sixteen (16) unrelated adults and provides supervision and personal care services to at least three (3) of the unrelated adults.

Adult Hotel or Motel: A commercial establishment which offers accommodations for any form of consideration, which provides patrons with closed-circuit television transmissions, films, motion pictures, video cassettes, slides, or other photographic reproductions, characterized by the depiction of “specified sexual activities” or “specified anatomical areas”, and which advertises the availability of this sexually-oriented type of material by means of a sign visible from a public right-of-way, or by means of any off-premises advertising, including, but not limited to, newspapers, magazines, pamphlets or leaflets, radio or television; or offers a sleeping room for rent for a period of less than ten (10) hours; or allows a tenant or occupant to sub-rent the sleeping room for a time period of less than ten (10) hours.

Adult Motion Picture Theater: Means a commercial establishment where films, motion pictures, video cassettes, slides, or similar photographic reproductions that are distinguished or characterized by their emphasis upon the exhibition or description of specified sexual activities or specified anatomical areas are regularly shown for any form of consideration.

Adult Theater: Means a theater, concert hall, auditorium, or similar commercial establishment that, for any form of consideration, regularly features persons who appear in a state of nudity or semi nudity or live performances that are characterized by their emphasis upon the exposure of specified anatomical areas or specified sexual activities.

Affordable (a.k.a. Workforce) Housing: Residential housing determined as critical to local economic sustainability per the Warren County Comprehensive Plan, either for home ownership or rental, which is occupied, reserved or marketed for occupancy by households with a gross household income between eighty percent (80%) and one hundred percent (100%) of the County median gross income, as determined by the U.S. Department of Housing and Urban Development (HUD).

Aggregate Base: Crushed rock capable of passing through a $\frac{3}{4}$ in (19.05 mm) rock screen.

Agribusiness: Farming and the businesses associated with farming, such as the processing of farm products, the sales, and repair of farm equipment and sale of farm products.

Agricultural, Biotechnical: Agricultural use-related activity which uses bio-technical methods to modify living cells or organisms to produce substances or to perform processes involved in production of agricultural products.

Agricultural Processing: Processing operations for agricultural products, including, but not limited to, meat preparation, feed mills, dairy processing, timber processing, and fruit and vegetable packing, sorting, and grading, as an accessory use.

Agricultural Research Facility: A facility for the investigation, testing and demonstration of agricultural products and processes, including bio-technical agriculture, veterinary, soil, plant, and animal sciences.

Agricultural Structure: A structure used for purposes of agriculture as defined as this code and Ohio Revised Code Section 303.01.

Agriculture: Per Section 303.01 of the Ohio Revised Code, includes: farming; ranching; aquaculture; apiculture; horticulture; viticulture; animal husbandry, including, but not limited to, the care and feeding of livestock, equine, and fur-bearing animals; poultry husbandry and the production of poultry and poultry products; dairy production; the production of field crops, tobacco, fruits, vegetables, nursery stock, ornamental shrubs, ornamental trees, flowers, sod, or mushrooms; timber; pasturage; any combination of the foregoing; the processing, drying, storage, and marketing of agricultural products when those activities are conducted in conjunction with, but are secondary to, such husbandry or production; or as amended.

Agriculture Support Services: Uses, which provide support and services to agriculture.

Agritourism: An agriculturally related educational, entertainment, historical, cultural, or recreational activity, including you-pick operations or farm markets, conducted on a farm that allows or invites members of the general public to observe, participate in, or enjoy that activity.

Agritourism Provider: A person who owns, operates, provides, or sponsors an agritourism activity or an employee of such a person who engages in or provides agritourism activities whether or not for a fee.

Airport, Commercial: Any runway, or landing strip, and related facilities/services (e.g., fuel sales, storage, repair services, and aircraft sales) designed or used by any person for the landing and take-off of aircraft by the public for commercial purposes.

Airport, Private: Any runway, or landing strip, and related facilities designed or used by any person for the landing, take-off, and storage of aircraft on their respective property, principally for their own use.

Alteration: Any remodeling of, or addition to, the floor plan of a building or other structure, interior or exterior, which involves a change, or addition to, the supporting members (bearing wall, beams, columns, girders, etc.). Alteration also applies to the relocation of the building or structure or, in regards to a lot, any change in the recorded boundary and area of a parcel of record.

Amateur Radio Tower: Shall mean any structure designed and constructed primarily for the purpose of supporting one or more antennas, and used by a licensed amateur radio operator for amateur radio reception and transmission, with no commercial activity. The term includes any antenna or antenna array attached to the tower structure.

Animal, Exotic: Exotic animals includes, but is not limited to: Primates (gorillas, orangutans, chimpanzees, gibbons, siamangs, mandrills, drills, baboons, Gelada baboons only); Carnivores (all wolves, all bears, lions, tigers, leopards, jaguars, cheetahs, cougars); Proboscidea (all elephants); Perissodactyla (all rhinoceroses); Artiodactyla (all hippos and African buffalos); Crocodylia (crocodiles and alligators); Serpentes (all poisonous snakes); and Amphibians (all poisonous species).

Animal Wastes:

Excreta, bedding, wash waters, waste feed, and silage drainage from agricultural animals.

Apartment: A unit within a multiple-unit structure with sanitation and cooking facilities intended for use as a residence by a single household.

Appeal to the BZA: An application filed with, and requesting of, relief to be granted by the Board of Zoning Appeals (BZA) from an alleged error in any order, requirement, decision, or determination of any requirement of this Code imposed upon the person filing the appeal by the zoning inspector.

Appeal to a Court of Competent Jurisdiction: Per Chapters 2505 and 2506 of the Ohio Revised Code, a timely notice filed with the Board of Zoning Appeals (BZA) once it has issued a final order, adjudication, or decision that determines the rights, duties, privileges, benefits, or legal rights of the person filing such appeal, and upon exhausting this condition precedent, such matter may be reviewed by the Court of Common Pleas of Warren County, Ohio.

Aquifer: A consolidated or unconsolidated geologic formation or series of formations that are hydraulically interconnected and that have the ability to receive, store or transmit water.

Arcade, Amusement: A commercial facility wherein electronic games are played. Bingo and gambling devices are not included in this definition.

Asbestos: Not defined in ORC – Webster’s defines it as “any of several minerals (as chrysotile) that readily separate into long flexible fibers, that cause asbestosis and have been implicated as causes of certain cancers, and that have been used especially formerly as fireproof insulating materials.”

Assisted Living Facility: Not used in ORC – they do have "Residential Care Facility", which means a home that provides either of the following:

- (a) Accommodations for seventeen (17) or more unrelated individuals and supervision and personal care services for three (3) or more of those individuals who are dependent on the services of others by reason of age or physical or mental impairment;
- (b) Accommodations for three (3) or more unrelated individuals, supervision, and personal care services for at least three (3) of those individuals who are dependent on the services of others by reason of age or physical or mental impairment, and, to at least one of those individuals, any of the skilled nursing care authorized by section 3721.011 [3721.01.1] of the Revised Code.

Area of Land Affected on a Mineral Extraction Site: The area of land which has been excavated, or upon which a spoil bank exists, or both.

Basement: The floor space in a building, finished or unfinished, as living space, which is partially or wholly underground.

Batching Plant: An industrial facility used for the production of asphalt or concrete, or asphalt or concrete products, including facilities for the administration or management of business, the stockpiling of bulk materials used in the production process or of finished products manufactured on the premises, and the storage and maintenance of required equipment, but not including retail sale of stockpiled bulk materials or finished products. (in compliance with the ORC1514.01)

Bed and Breakfast: A business conducted in and by the residents of a single-family dwelling, wherein sleeping rooms are offered for pay to transient guests.

Berm: A man-made, linear earthen mound of at least eighteen (18) inches in height from grade designed to provide, buffering or screening of undesirable views, abate noise trespass, etc. (also see Buffer).

Best Management Practice (BMP): A practice or combination of practices that is determined to be the most effective and practicable including technological, economic, and institutional controls as a means of complying with the applicable standards of Chapter 903 of the Revised Code. BMPs may include structural and non-structural practices, conservation practices, prohibition of practices, schedules of activities, operation and maintenance procedures, and other management practices to prevent or reduce the pollution of waters of the state. BMPs also include treatment requirements, operating procedures, and practices to control facility site runoff, spillage, or leaks, sludge or waste disposal, or drainage from raw material storage. (OAC 901:10-1-01)

Boarding House: A dwelling kept, used, maintained, advertised or held out to the public to be a place where long term [as provided in Section 3.203 (A) (3)] accommodations are provided for compensation for thirty (30) days or more.

Buffer: An area of healthy and viable vegetation or mounded earth, adjoining or surrounding a land use, which is intended to screen and soften the effects from another use.

Building: Any structure consisting of foundations, walls, columns, girders, beams, floors, and roof, or a combination of any number of these parts, with or without other parts or appurtenances. (ORC 3781.06)

Building Height: The tallest vertical distance from the finished grade at the front of the building to: (a) the highest point of a flat roof; (b) the deck line of a mansard roof; (c) the average height between the eaves and ridge of gable, hip, and gambrel roofs; or (d) the average height between high and low points of a shed roof (see illustration).

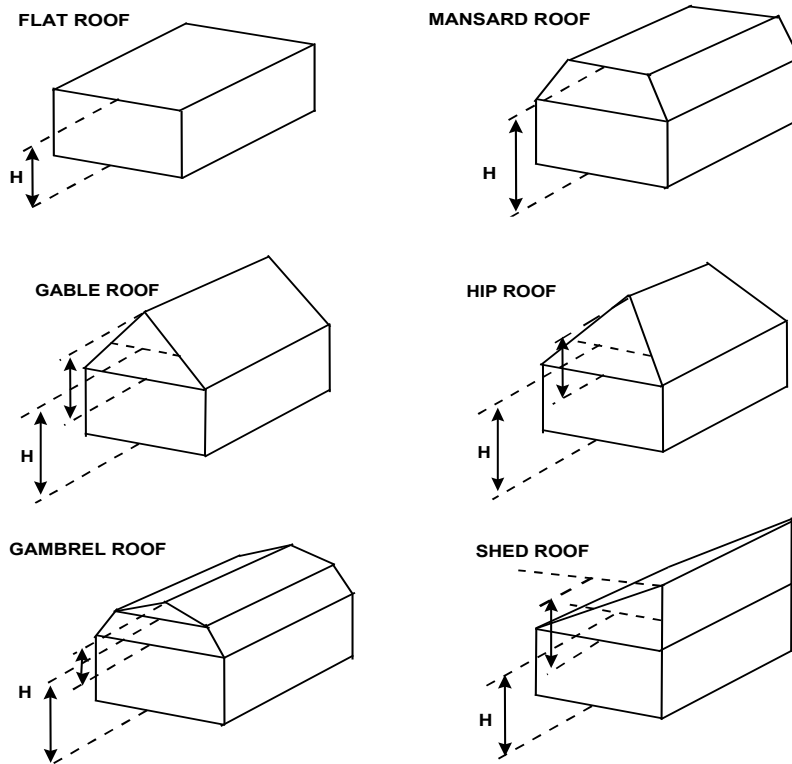

Building Line: (See Setback)

Building, Principal: The main building(s) on a parcel in which the primary use is conducted.

Bulking Agent: Any material added to a composting system to provide structural support, improve aeration, or absorb moisture from the decomposing waste. (O.A.C. 3745-27-01(F)(5)).

Business: Any work, occupation, profession, activity, or buying and selling of commodities and services, commerce, or trade.

Business Activity: Any activity performed, conducted, maintained, or operated by one (1) or more person(s) as their work, occupation, profession, or involving buying and selling of commodities, the provision of services, commerce or trade, or approved home occupation in production and/or selling of goods or provision of service(s) in exchange for some form of consideration.

Business, Place Of: A place where the business activity as defined herein is conducted.

Campground: An area or place (such as a field or grove) used for a camp, camping, or for a camp meeting.

Camping Units: Portable dependent recreational vehicles, tents, sleeping equipment, and similar camping equipment used for travel, recreation, vacation, or business purposes. (O.R.C. 3729.01 (P)).

Caretaker: An individual who is actively involved in on-site maintenance, service, security, or operations of a use. A proprietor may serve as a caretaker.

Caretaker Dwelling: An accessory residential unit occupied by a caretaker.

Cellar: (See Basement.)

Central Processing Facility: A site area location or tract of land on which one (1) or more building(s) or other completely contained installations engineered thereon are used for purposes of a solid waste transfer station, recycling facility, or resource/material recovery facility, but excluding incineration fueled by solid waste or that would burn it as a means for its reduction, disposal, or recovery as an energy resource.

Central Sanitary Sewage System: An operating system of components and facilities for wastewater collection, treatment and disposal, whether public or private, which has been approved by the Board of Warren County Commissioners (BOCC) for location within a sanitary sewer improvement area designated by Resolution of the BOCC for allowance thereof in the Warren County Sewer District or alternatively in an area of the District released by BOCC Resolution to another entity to provide such service, determined solely at the discretion of the BOCC.

Cemetery: A burial ground for earth interments; a mausoleum for crypt entombments; a columbarium for the deposit of cremated remains; and, a scattering ground for the spreading of cremated remains. (O.R.C. 1721.21).

C.E.R.C.L.A.: The Comprehensive Environmental Response Compensation and Liability Act, as amended by the Superfund Amendment and Reauthorization Act, 42, U.S.C. 9601 et seq, as amended.

Channel: The area between definite banks of a natural or artificial stream which confine and convey continuous or periodic flows of surface water, as defined in Ohio Revised Code Section 6105.01.

Churches-Places of Worship, Large: Establishments that exceed ten thousand (10,000) square feet.

Churches-Places of Worship, Small: Establishments that are less than ten thousand (10,000) square feet and do not include a school or commercial daycare.

Cistern: A tank that stores excess rainwater runoff.

Clinic: A building, or portion thereof, the use of which provides medical, dental, or psychiatric services to outpatient clients only.

Club: Building and facilities owned or operated by persons as a non-profit corporation, association, or other organization for social, intellectual, and recreational purposes, for the members and their guests.

Commencement of Permit Activity: Evidence of physical construction and/or change of use on the site for which a zoning permit has been issued.

Commercial Use: A type of nonresidential land use that has one or more of the following characteristics: 1) the use is service-oriented; 2) the use sells retail items; 3) the use sells goods or products on a wholesale basis; or 4) the use has or has the need for open storage areas or warehouses its products. This includes both business establishments that customarily occupy standard retail/office space that require patrons to visit the establishment and off-site businesses that due to equipment and vehicle storage or the processes used, typically require facilities in addition to standard retail/office space.

Commercial Kennel: Any property where a person, partnership, firm, company, or corporation professional engage in the business of breeding dogs for hunting or for sale. (955.02 ORC defines kennel owner)

Commercial Tent: A temporary and portable structure used for non-residential purposes and which meets the Uniform building or Fire Code.

Commercial Support Services: An establishment providing services to business establishments or individual, on a fee or contract basis, including but not limited to advertising services; janitorial; business equipment and furniture sales or rental; protective services; telecommunications; window cleaning; photocopy and mailing service; commercial photography studio; and other such services.

Commercial Vehicle: Means any motor vehicle designed or used to transport persons or property that meets any of the following qualifications: (ORC 4506.01)

- (a) Any combination of vehicles with a combined gross vehicle weight rating of twenty-six thousand and one (26,001) or more, provided the gross vehicle weight rating of the vehicle or vehicles being towed is in excess of ten thousand (10,000) pounds;
- (b) Any single vehicle with a gross vehicle weight rating of twenty-six thousand and one (26,001) or more, or any such vehicle towing a vehicle having a gross vehicle weight rating that is not in excess of ten thousand (10,000) pounds;
- (c) Any single vehicle or combination of vehicles that is not a class A or class B vehicle, but is designed to transport sixteen (16) or more passengers including the driver;
- (d) Any school bus with a gross vehicle weight rating of less than twenty-six thousand and one (26,001) that is designed to transport fewer than sixteen (16) passengers including the driver;
- (e) Is transporting hazardous materials for which placarding is required under subpart F of 49 C.F.R. part 172, as amended;
- (f) Any single vehicle or combination of vehicles that is designed to be operated and to travel on a public street or highway and is considered by the Federal Motor Carrier Safety Administration to be a commercial motor vehicle, including, but not limited to, a motorized crane, a vehicle whose function is to pump cement, a rig for drilling wells, and a portable crane.

Community Based Residential Social Service Facilities: Means health and social services provided to persons in their own homes or in community care settings, and includes any of the following:

- (1) Case management;
- (2) Home health care;
- (3) Homemaker services;
- (4) Chore services;
- (5) Respite care;
- (6) Adult day care;
- (7) Home-delivered meals;
- (8) Personal care;
- (9) Physical, occupational, and speech therapy;
- (10) Transportation;
- (11) Any other health and social services provided to persons that allow them to retain their independence in their own homes or in community care settings. (ORC uses 173.14)

Composting: Composting is defined as the decomposition of organic matter that requires controlled conditions and yields temperatures conducive to thermophilic microorganisms, resulting in humus-like organic material. (OAC 3745-27-01 (C) (4)).

Composting Facilities: Any site, location, tract of land, installation or building used for composting as the method for disposing of solid waste and which are classified according to Ohio Administrative Code:

Class I: Solid Waste Composting Facilities: Means a facility where the owner or operator may accept yard waste, agricultural waste, animal waste, food scraps, mixed solid waste, bulking agents, additives, and authorized alternative materials.

Class II: Solid Waste Composting Facilities: Means a facility where the owner or operator may accept yard waste, agricultural waste, animal waste, food scraps, bulking agents, additives, and authorized alternative materials.

Class III: Solid Waste Composting Facilities: Means a facility where the owner or operator may accept yard waste, agricultural waste, animal waste, bulking agents, and additives.

Class IV: Solid Waste Composting Facilities: Means a facility where the owner or operator may accept only yard waste, bulking agents, and additives limited to urea and bacterial or fungal inoculum.

Common Area: Parcel(s) of land, in a certain development, inclusive of facilities and improvements thereon, which are collectively owned and maintained by the owners of the building lots in the same development, for the use, maintenance, and enjoyment by those owners and their guests.

Comprehensive Plan of Warren County, Ohio: A series of component documents (a.k.a. "elements") recommended by the Warren County Regional Planning Commission (RPC) and adopted by the Warren County Board of Commissioners, which documents the goals, objectives, and policies for capital improvements programming, economic development, housing, natural hazards mitigation, land use, parks and open space, sanitary sewer, water, transportation and any other specified subject matters involving or related to use and development of land within Warren County, Ohio.

Conditional Use: A use that is potentially acceptable in a Zoning District, but not necessarily appropriate in all locations.

Conditional Use Permit: A zoning permit issued by the Zoning Inspector for a conditional use approved by the Board of Zoning Appeals (BZA).

Conservation Development: A type of development in which residential lot sizes are reduced below what is required by the zoning district in which located in return for providing permanent open space within the development. (Also see Open Space).

Construction and Demolition Debris: Means those materials resulting from the alteration, construction, destruction, rehabilitation, or repair of any man-made physical structure, including, without limitation, houses, buildings, industrial or commercial facilities, or roadways. This definition does not include materials identified or listed as solid wastes, infectious wastes, or hazardous wastes pursuant to Chapter 3734 of the Ohio Revised Code and rules adopted thereunder; liquids including containerized or bulk liquids; materials from mining operations, non-toxic fly ash, spent non-toxic foundry sand and slag; or reinforced or non-reinforced concrete, asphalt, building or paving brick, or building or paving stone that is stored for a period of less than two (2) years for recycling into a usable construction material. For the purposes of this definition, "material resulting from the alteration, construction, destruction, rehabilitation, or repair of any man-made physical structure" are those materials that form the structure, and those materials directly affixed to the structure such as brick, concrete, and other masonry materials, stone, glass, wall coverings, plaster, drywall, framing and

finishing lumber, roofing materials, plumbing fixtures, heating equipment, electrical wiring and components containing no hazardous fluids or refrigerants, insulation, affixed carpeting, asphaltic substances, metals incidental to any of the above, and weathered railroad ties and utility poles. Materials from construction may also include empty packaging material consisting of, without limitation: wood, corrugated container board, paper, metal, and/or plastic directly resulting from construction material packaging. Material resulting from the alteration, construction, destruction, rehabilitation, or repair does not include materials that are required to be removed before demolition occurs, materials that are not affixed to the structure or that are otherwise contained within the structure such as solid wastes, yard waste, packaging materials not directly incidental to construction, pallets, containers, and drums including caulking tubes, furniture, appliances, tires, batteries, and fuel tanks.

Construction/Demolition Debris Facility: Any site, location, tract of land, installation, or building used for the disposal of material from construction or demolition operations. Material from construction or demolition operations are those items affixed to the structure being constructed or demolished such as brick, concrete, stone, glass, wallboard, framing, finished lumber, roofing materials, plumbing, plumbing fixtures, heating equipment, wiring, and insulation, but excludes materials whose removal has been required prior to demolition.

Contaminant: Any physical, chemical, biological, or radiological substance or matter that has an adverse effect on air, water, or soil.

Convalescent Home: (See Institutional Care Facility, as a type of Community-Based Residential Social Service Facility.)

Correctional Facility: A penal institution publicly or privately operated that houses persons awaiting trial or persons serving a sentence imposed by a court of law.

Country Inns: A business, other than a hotel or bed and breakfast, that offers overnight accommodations in a rural area (RU,R1A), and wherein dining, banquet and other meeting facilities may be operated.

Court a.k.a. Courtyard: An open area of ground on a building use site that is partially or completely surrounded by walls, buildings, or fencing and typically decoratively landscaped, unobstructed to the sky and usually entirely internal and not part of a front, side, or rear yard as elsewhere defined on a building site.

Cross Access: An easement or service drive providing vehicular access between two (2) or more contiguous sites so that the driver does not need to reenter the public street system.

Cul-de-sac Lots: A lot that fronts on or takes access from a cul-de-sac. A lot shall be considered to be a cul-de-sac lot if the lot has more than one half (1/2) of its required frontages on the cul-de-sac.

Cut Off: The point at which all light rays emitted by a lamp, light source, or luminaire are completely eliminated (cut off) at a specific angle above the ground.

Cut Off Angle: The angle formed by a line drawn from the direction of light rays at the light source and a line perpendicular to the ground from the light source above which no light is emitted.

Cut Off Luminaire: A source of illumination with elements such as shield, reflectors or refractor panels that direct and cut off the light at a cut off angle less than ninety (90) degrees.

Damaged or Diseased Trees: Trees that have: split trunks; broken tops; heart rot; insect or fungus problems that will lead to imminent death; undercut root systems that put the tree in imminent danger of falling; lean as a result of root failure that puts the tree in imminent danger of falling; or any other

condition that puts the tree in imminent danger of being uprooted or falling into or along a watercourse or onto a building or structure.

Day Care: The care, protection, and guidance of one (1) or more children or adults on a regular basis, for periods of less than 24 hours per day, in a place other than their own dwelling unit.

Debris: Trash, litter, refuse or rubbish on any property that is not properly contained for disposal in accordance with applicable regulations, so that such items or materials are open to haphazard transport off-site by wind or water, a potential hazard to public health and safety, or a visual eyesore, barring containment and/or removal. Debris does not include bulking agents used for active composting permitted by zoning nor construction or demolition debris on a site permitted by zoning for disposal.

Density: A unit of measurement designating the number of dwelling units per acre of land, calculated as follows:

Density, Gross: The total number of dwelling units divided by the total acreage of the development site.

Density, Net: The total number of dwelling units divided by the acreage to be developed only for residential use, exclusive of areas for street/road rights-of-way.

Developed Spring: Any spring which has been permanently modified by the addition of pipes or a collection basin to facilitate the collection and use of spring water. [OAC 3745-27-01 (D) (2)]

Direct Market Business: A commercial enterprise in which agricultural products produced on a site are marketed and sold directly to consumers without an intermediate wholesaler or distributor, other than a farm co-op organization. Direct market business may include such use activities as pick-your-own (“PYO”) operations and operations in which delivery of products is made directly to consumers, such as “farm share” arrangements under which periodic delivery of farm products is made for a subscription fee.

“Distinguished or characterized by their emphasis upon”: means the dominant or principal character and theme of the object described by this phrase. For instance, when the phrase refers to films “that are distinguished or characterized by their emphasis upon the exhibition or description of specified sexual activities or specified anatomical areas,” the films so described are those whose dominant or principal character and theme are the exhibition or description of specified sexual activities or specified anatomical areas.

Distribution Facilities/Center: A facility that is used for receipt, temporary storage, and redistribution of goods according to orders as they are received. These establishments also provide a range of services, often referred to as logistics services, and related to the distribution of goods. Logistics services can include labeling, breaking bulk, inventory control and management, light assembly, order entry and fulfillment, packaging, pick and pack, price marking and ticketing, and transportation arrangement.

Drive-Through: A business designed to service customers who stay in their vehicles.

Dual Zoning Option: Consistent with the land use plan element of the most current Warren County Comprehensive Plan, a parcel or parcels on which the existing zoning is opted with an available “secondary” zoning classification option.

Dwelling: Any building or portion thereof designed or intended to be used exclusively for residence purposes, but not including a mobile home or a non-permanently sited manufactured home on any site outside of a manufactured homes park, nor a tent, cabin, trailer, travel trailer, trailer coach, camper on a truck, or any other type of recreational vehicle.

Dwelling, Multiple-Family: A building or portion thereof designed for or occupied by more than two (2) families.

Dwelling, Single-Family: A building designed for, or occupied exclusively by, one (1) family.

Dwelling, Two-Family: A building designed for, or occupied exclusively by, two (2) families.

Dwelling Unit: A residential use building or portion therein containing one (1) or more rooms used, designed, or intended for occupancy as a single household unit, in providing complete permanent facilities per all applicable Code requirements for living, sleeping, cooking, eating, bathing, washing, and sanitation.

Easement: A particularly described area of exclusive or non-exclusive legal interest in, on, under, over, or through a portion of a parcel of land or appurtenance thereto created by a written instrument whereby the owner of the parcel grants to the owner of a separate parcel of land or appurtenance thereto, or utility, the right to make lawful and beneficial use of the particularly described area.

Ecotourism: Environmentally responsible travel to natural areas, in order to enjoy and appreciate the natural scenery, history, indigenous ecosystems, native plant or animal species, and accompanying cultural features, both past and present that promote conservation, have a low visitor impact, and provide for beneficially active socio-economic involvement of local people. Facilities for an ecotourism enterprise may include recreational outfitters.

Employee: A person who works for another person or entity (the employer) under which the employer has the right to control the details of the employee's work performance.

Escort: A person who, for any form of consideration, agrees or offers to act as a companion, guide or date for another person, or agrees or offers to privately model lingerie or privately performs a striptease for another person.

Escort Agency: A person or business association that for any form of consideration provides or offers an escort(s) for another person.

Essential Services: Public or private utilities, whether at, below, or over the land surface where located, which are necessary for the exercise of the principal use or service of the principal structure on a lot, including, as examples: gas, electric, steam, water, wastewater disposal, stormwater drainage, telecommunications systems, and accessories thereto and other public use facilities, such as fire/EMS and police stations, schools, government administrative buildings, etc., and the like.

Establishment: A place of business, firm, club, or institution.

Excavation: The altering of the topographic elevation and configuration (grade) of a land area.

Family: A person or group of persons occupying a single dwelling unit and living as a single housekeeping unit, as distinguished from a group occupying a hotel or motel as herein defined.

Family Cemetery: A cemetery containing the human remains of persons, at least three-fourths of whom have a common ancestor or who are the spouse or adopted child of that common ancestor.

Family Home and Day Care: (Have two types of Family care home in ORC under 5104.01) (RR) "Type A family day-care home" and "Type A home" mean a permanent residence of the administrator in which child care or publicly funded child care is provided for seven (7) to twelve (12) children at one time or a permanent residence of the administrator in which child care is provided for four (4) to twelve (12) children at one time if four (4) or more children at one time are under two (2) years of age. In counting children for the purposes of this division, any children under six (6) years of

age who are related to a licensee, administrator, or employee and who are on the premises of the type A home shall be counted. "Type A family day-care home" and "type A home" do not include any child day camp.

(SS) "Type B family day-care home" and "Type B home" mean a permanent residence of the provider in which child care is provided for one to six (6) children at one time and in which no more than three (3) children who are under two (2) years of age at one time. In counting children for the purposes of this division, any children under six (6) years of age who are related to the provider and who are on the premises of the type B home shall be counted. "Type B family day-care home" and "type B home" do not include any child day camp.

Farm: Land that is composed of tracts, lots, or parcels totaling not less than ten acres devoted to agricultural production or totaling less than ten acres devoted to agricultural production if the land produces an average yearly gross income of at least twenty-five hundred dollars from agricultural production.

Farm (or farmstead if including a dwelling): Parcel(s) of land and the buildings or other structures thereon which are owned, maintained and operated as a place or group of places as a use establishment or other operation for agriculture as defined in this Code.

Farm-Based Tourism: Activities conducted on a working farm and offered to the public or to invited groups for the purpose of recreation, education, entertainment, hospitality, direct sales or active involvement in a farm operation of the farm and may include the following:

- (a) **Outdoor Recreation:** fishing, wildlife study, horseback riding, sleigh/carriage/ wagon rides, stargazing, hiking, campfires, community gardens.
- (b) **Educational experiences:** cooking classes, wine tasting, school tours, cannery tours, garden/nursery tours, agricultural technical tours, historic agricultural exhibits, food processing, dairy, cider making, gardening and plant identification.
- (c) **Entertainment:** harvest festivals, concerts, barn dances, petting zoo, hunting/working dog trials/training, haunted house, haunted hayride, corn maze, pumpkin carving, egg painting, miniature golf, toddler rides, playground areas, scavenger hunts, craft fair, antique shows, art shows.
- (d) **Hospitality services:** bed and breakfast, retreat center, assembly area, country weddings, party receptions, picnic, family reunions, catering, country store, gift shop, fair food.
- (e) **Direct sales:** u-pick, roadside stand or nursery sales with parking spaces for more than ten (10) vehicles.
- (f) Other uses as determined appropriate by the board of zoning appeals.

Farm Equipment Sales, Rental, and/or Repair Service: An establishment for the sale, rental, and/or repair service of equipment normally or routinely used on farms and gardens, and sales of related parts, tools, and accessories.

Feedlot: An agricultural use facility consisting of any pen, corral, or structure wherein livestock are maintained in close quarters for the purpose of fattening for market, subject to all necessary permitting from the Ohio Environmental Protection Agency (OEPA) for waste treatment and disposal.

Fence: An enclosure or barrier consisting of vegetation or otherwise constructed of boards, masonry, posts, wire, wrought iron, or the like.

Fifth-Wheel Trailer: Means a vehicle that is of such size and weight as to be movable without a special highway permit, that has a gross trailer area of four hundred (400) square feet or less, that is constructed

with a raised forward section that allows a bi-level floor plan, and that is designed to be towed by a vehicle equipped with a fifth-wheel hitch ordinarily installed in the bed of a truck. [ORC 4501.01(6) (d)]

Fill: Soil, rock, sand, gravel, or a combination with other materials found suitable as fill by the applicable involved authority to make such determination, which exceeds one hundred (100) cubic yards total volume and/or more than four (4) feet in height at its deepest point of placement or dumping on or into ground.

Filling: The placement or dumping of fill on or into ground, excluding such which is not fill for common household gardening, composting and yard care.

Firewood, Processed: Firewood is raw material that has been processed for use in a fireplace, stove, or other heat generating source, by removing all non-wood or non-combustible material, reduced to a size and length for the said foregoing uses and stacked in an orderly fashion.

Firewood, Raw Material: Raw material that has not been, but can be, processed into firewood. Examples include, but are not limited to, logs, branches, limbs, pallets, untreated dimensional lumber, and other wood products that have not been painted, stained, chemically treated, or coated.

Fire Lane: A continuous, posted, and/or marked access way on a property for the effective, safe ingress and egress of fire suppression and emergency response vehicles and personnel.

Fixture, Temporary: A fixture which is permitted without any foundation or footing, and which is removed when the designated period, activity, or use per the zoning certification for which the fixture was erected has ceased. Such fixtures include but is not limited to tents, portable bandstands, bleachers, reviewing stands, a manufactured home used in conjunction with construction activities or other fixtures of similar character.

Flood, One Hundred (100) Year: The temporary inundation of normally dry land along a watercourse by a flood that is likely to occur once in a one hundred (100) year period or that has a one percent (1%) chance of occurring in any given year within a one hundred (100) year period (see illustration).

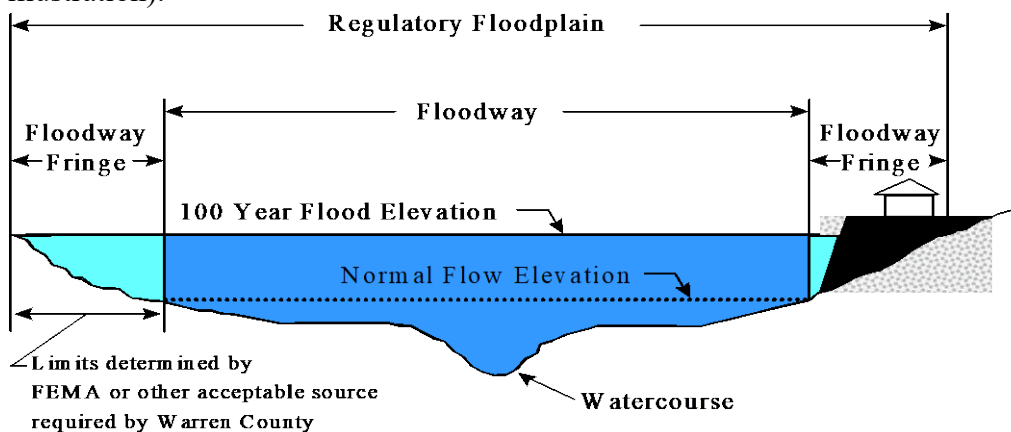

Floodplain, Regulatory: Land under and along a watercourse which is subject to inundation by a one hundred (100) year flood, as determined by the Federal Emergency Management Agency (FEMA) or other source determined acceptable per the Warren County Flood Damage Reduction Regulations (see illustration).

Floodway: Land under and along a watercourse in a regulatory floodplain which is calculated or otherwise observed as required to carry and discharge the flood waters of a one hundred (100) year flood without obstruction, as designated by the Federal Emergency Management Agency (FEMA) or other acceptable source (see illustration).

Floodway Fringe: Land along a floodway in a regulatory floodplain which as calculated or observed serves as a storage area for the flood waters of a one hundred (100) year flood, as designated by the Federal Emergency Management Agency (FEMA) or other acceptable source (see illustration).

Floor Area; Gross: The total gross area of all the floors in a building, as measured from the exterior surface of the exterior walls of the building or from the centerline of common walls separating buildings or units within a building. (Also see Living Space.)

Floor Area Ratio: The mathematical expression determined by dividing the Gross Floor Area of a building or structure, including all accessory buildings, by the area of the lot on which they are located.

Foot-Candle: A unit of illumination produced on a surface, all points of which are one (1) foot from a uniform point source of one (1) candle.

Footprint; Building: The area within the perimeter of a building at ground level.

Foster Home: Ohio Revised Code § 5103.02 means a private residence in which children are received apart from their parents, guardian, or legal custodian, by an individual reimbursed for providing the children non-secure care, supervision, or training twenty-four (24) hours a day. "Foster home" does not include care provided for a child in the home of a person other than the child's parent, guardian, or legal custodian while the parent, guardian, or legal custodian is temporarily away. Family foster homes and specialized foster homes are types of foster homes.

Foundation, Permanent: Permanent masonry, concrete, or a footing or foundation approved by the manufactured homes commission pursuant to chapter 4781 of the Ohio Revised Code, to which a manufactured or mobile home may be affixed. (See O.R.C. § 3781.06)

Garage, Residential: A building or a part of a residence, in which to store vehicles and personal property incidental to the use of the property.

Garage, Non-Residential: A commercial building where vehicles are repaired and/or serviced.

Garage, Parking: A commercial building for the storage of vehicles.

Glare: Light emitted from a luminaire resulting in a spot of intensity great enough to reduce a viewer's ability to see, and in extreme cases such to cause momentary blindness.

Golf Course: A tract of land lay out with at least nine (9) holes for playing the game of golf and improved with tees, greens, fairways, and hazards and that may include a clubhouse and shelter. This does not include miniature golf.

Grade: The finished ground level adjoining the building at all exterior walls.

Grandfathered: (See Non-Conforming, Legal)

Group Home: A residential use, as a type of Community-Based Residential Social Service Facility, which is operated by private citizens or a social service agency and which has a valid license from the appropriate state or local agencies of lawful authority to license the operation to provide room and board, personal care, habilitation services, and supervision in a family setting for more than eight (8) but not more than sixteen (16) persons with developmental disabilities. A developmental disability shall be defined as a disability that originated before the attainment of eighteen (18) years of age and can be expected to continue indefinitely, constitutes a substantial handicap to the person's ability to function normally in society, and is attributable to mental retardation, cerebral palsy, epilepsy, autism,

or any other condition found to be closely related to mental retardation because such condition results in similar impairment of general intellectual functioning or adaptive behavior or requires similar treatment and services.

Hazardous Wastes: Means waste that is regulated by the Ohio Environmental Protection Agency specifically as hazardous waste and/or exhibits one (1) or more characteristics of hazardous waste as defined in Ohio Administrative Code Chapter 3745-51.

In further definition, hazardous waste also means any waste or any combination of wastes in a solid, liquid, semi-solid, or contained gaseous form that, in the determination of the Director of Environmental Protection, because of its quantity, concentration, or physical or chemical characteristics, may:

- (a) Cause or significantly contribute to an increase in mortality or an increase in serious irreversible or incapacitating reversible illness; or incapacitating reversible illness; or,
- (b) Pose a substantial present or potential hazard to human health and safety or to the environment when improperly stored, transported, disposed of, or otherwise managed. Hazardous wastes include any substance identified as such under the Resource Conservation and Recovery Act of 1976 (42 U.S.C. 692 et seq.), as amended, and do not include any substance that is subject to the Atomic Energy Act of 1954 (42 U.S.C. 2011 et seq.), as amended.

Heavy Equipment: Refers to heavy-duty vehicles or equipment they may include equipment designed for executing construction tasks or earthwork operations: earth movers; engineering vehicles; large vehicles that require an oversize/overweight permit from the Ohio Department of Motor Vehicles to be transported over public highways; and vehicles that have more than five (5) axles or haul heavy equipment.

Historic Structure: (ORC uses the term historic building under 149.311)"Historic building" means a building, including its structural components, that is located in this state and that is either individually listed on the National Register of Historic Places under 16 U.S.C. 470a, located in a registered historic district, and certified by the state historic preservation officer as being of historic significance to the district, or is individually listed as a historic landmark designated by a local government certified under 16 U.S.C. 470a(c).

Home for Adjustment: A residential facility, as a type of Community-Based Residential Social Service Facility, operated by a court, a social service agency, or private citizens which provides therapy, counseling, and a residential environment for eight (8) or less adolescents or adults for the following purposes: 1) to assist them in recuperating from the effects of drugs or alcohol or, 2) to assist them in adjusting to living with the handicaps or emotional or mental disorder in lieu of or subsequent to confinement within an institution, or 3) to provide housing and a supervised living arrangement in lieu of or subsequent to placement within a correctional institution. The residents of any home for adjustment shall be limited to those individuals who will not pose a threat to life or property within the community, as determined by the responsible court or social service agency, and all homes for adjustment must have a valid license from the appropriate court or agency having the lawful authority to license the operation.

Home Occupation: A non-residential use activity that may be permitted in a residence.

Hotel: A commercial use building or group of buildings, containing any combination of guestrooms in which lodging and boarding is offered to guests for compensation, with access to the units being from interior lobbies, courts or halls.

Household: Is all persons who occupy a dwelling housing unit. (Per U.S. Census Bureau)

Housing Unit: A house, an apartment, a mobile home, a group of rooms, or a single room that is occupied (or if vacant, is intended for occupancy) as a separate living quarters, which are those in which the occupants live and eat separately from any other persons in the dwelling building and which have direct access from the outside of the building or through a common hall. The occupants may be single-family, one person living alone, two or more families living together, or a group of related or unrelated persons who share living arrangements. Persons not living in households are classified as living in group quarters. (Per U.S. Census Bureau)

Impervious Surface: Any material that prevents, impedes, or slows the infiltration or absorption of stormwater into the ground, including building roofs and concrete or asphalt pavement.

Impervious Surface Ratio: A ratio derived by dividing the amount of the site that is covered or hardened so as to prevent or impede the percolation of water into the soil mantle, including but not limited to buildings, swimming pools, roads, and parking areas, by the net area (excluding right-of-way) of the lot. This calculation excludes landscaping, surface water retention/detention facilities and those areas used exclusively for pedestrian circulation or outdoor recreational facilities.

Incinerator: Equipment, machine, device, article, structure, or part thereof, used to burn solid waste.

Industrial: Of, relating to, concerning, or arising from the assembling, fabrication, finishing, manufacturing, packaging, or processing of goods. (See Manufacturing)

Industrial, Light: Manufacturing or assembly that is capable of controlling the external effects of the process, such as odors, vibrations, emissions, or other nuisance characteristics through prevention or mitigation devices and where conduct of operations are within the confines of buildings. The processes carried on, the transportation involved, or the machinery or materials used do not interfere with the amenity of the surrounding area, and products are intended for end users rather than as intermediates for use by other industries.

Industrialized Unit: A building unit or assembly of closed construction, fabricated in an off-site facility, that is substantially self-sufficient as a unit or as part of a greater structure and requires transportation to the site of intended use, including units installed on the site as independent units, as part of a group of units, or incorporated with standard construction methods to form a completed structural entity, but does not include “manufactured home” or “mobile home” as defined in division (O) of Sec. 4501.01 of the Ohio Revised Code. (See ORC § 3781.06 (C)(3), as amended).

Infiltration Barrier: In situ geologic material, or added earthen material in the form of a recompacted soil liner and/or geotextile, situated under a waste disposal area in order to prevent leachate from infiltrating into underlying soil and groundwater.

Injection Well: A well into which fluids are injected, as classified per 3745-34-04, as amended.

In Situ: Soil and other earthen material that exists in its undisturbed geologic situation or location where it has been allowed to form in place throughout its geologic history of natural development, without having been excavated or otherwise disturbed or influenced by man (see Infiltration Barrier).

Institutional: A use of land and/or buildings located thereon owned and occupied and used exclusively for the benefit of members of a not-for-profit organization or the public.

Institutional Care Facility: Any residential facility, hospital, convalescent, nursing, or rest home, children’s homes, halfway houses, residential treatment camps, and training or correctional schools for children designed or used for more than sixteen (16) persons functioning for purposes of a family care home or a group home, or any residential facility designed or used for more than eight (8) persons under the purposes of a home for adjustment. All institutions shall possess a license from the appropriate state or local agency having the lawful authority to license the operation and may be

operated by private citizens, a social service agency, or a governmental authority. This definition excludes correctional facilities. (as defined)

Internet Sweepstakes Establishment: An establishment that promotes the sale of prepaid internet time cards, phone cards or similar device to retail customers in varying amounts for use at its business location which entitle each cardholder to participate in sweepstakes. The sweepstakes system allows a customer to use the phone card, internet time cards or similar device at an internet sweepstakes game terminal to browse the internet or participate in games which reveal sweepstakes entries, prizes, prize values or the like.

Internet Sweepstakes Game Terminal: A computer, machine, game or apparatus which, upon the insertion of a coin, token, access number, magnetic card, or similar object, or upon the payment of anything of value, may be operated by the public for use as a contest or game of chance, and which provides the user with a chance to win anything of value.

Invasive, Species: Any plant listed by the ODNR as invasive, whose introduction causes or is likely to cause harm to the economy, environment, or to human health.

Joint Access: A single access point connecting two (2) or more contiguous sites to a public roadway that serves more than one property or developments including those in different ownership.

Junk: One or more objects, articles, or materials where as such items are:

- (a) poorly maintained, deteriorated, damaged, or in a destroyed condition; or,
- (b) careless, haphazard, disorganized placement; or,
- (c) lack of cover from sun and weather exposure.

Junk Vehicle: Any vehicle, whether motorized or otherwise made mobile for purposes of travel on or off roads, through air or on or under water and/or to transport a driver, passengers and/or materials of any kind, and can be described by one (1) or more of the following:

- (a) Inoperable in accordance with manufactured design and/or for safe and/or lawful use;
- (b) Damaged and/or dismantled so as to be unsafe or unlawful to operate and/or could not be restored to safe, lawful operation within seven (7) days;
- (c) Expired registration, if required to be registered; and,
- (d) Uninsured if required to be insured.

Junk Yard (a.k.a. Salvage Yard): A use permitted on all or part of a property that is not completely contained within a building, but which is completely contained within an area which is surrounded by a solid fence or wall and perhaps natural landscaping such that it is not viewable from any other property, and wherein placement: of junk, and/or junk vehicles, inclusive of used, wrecked and/or dismantled; vehicle, appliance, and machine parts; building, electrical, heating, air conditioning, and plumbing fixtures; scrap metal, lumber, concrete blocks, bricks, plastics, rubber, wire, cable, rope or glass are permitted, in accordance with applicable regulations of the zone in which the property is located, for the purpose of being dismantled, handled, wrecked, sorted, salvaged, or reclaimed for restoration or reuse, or to be shipped elsewhere for reuse or disposal. A junk yard is not considered a central processing facility or disposal site for solid waste or construction/demolition debris as otherwise defined by this Code.

Kennel: A structure or premises used for the housing, grooming, breeding, boarding, training, selling or other animal husbandry activities for dogs, cats or other animals for financial or other compensation.

Landscaping: Vegetation, including grass, groundcover, flowers, shrubs, and trees, for the purposes of adornment and soil erosion and sedimentation control of yard or other areas on a site and non-vegetation elements such as logs, rocks, fountains, water features, and contouring of the earth into mounds and depressions.

Land Use Plan: (See Comprehensive Plan of Warren County, Ohio)

Large Scale Retail: Establishments that exceed seventy-five thousand square (75,000) feet in gross floor area.

Leachate: Liquid that has come in contact with or been released from solid waste or construction/demolition debris.

Legal Non-Conforming: (ORC 303.19) The lawful use of any dwelling, building, or structure and of any land or premises, as existing and lawful at the time of enactment of a zoning resolution or amendment thereto, may be continued, although such use does not conform with the provisions of such resolution or amendment, but if any such non-conforming use is voluntarily discontinued for two years or more, any future use of land shall be in conformity with sections 303.01 to 303.25, inclusive, of the Revised Code. The board of county commissioners shall provide in any zoning resolution for the completion, restoration, reconstruction, extension, or substitution of non-conforming uses upon such reasonable terms as are set forth in the zoning resolution.

Light Trespass: Light which goes beyond the boundary of the site on which the light source is located.

Limestone Quarry: A mineral extraction site and mining operation where limestone is the principal material excavated for commercial sale or use in another location, but does not include such excavation resulting from the construction of a sanitary landfill.

Living Space: The total of the finished interior floor area for each story in a dwelling unit for the purpose of living, sleeping, cooking, eating, bathing, washing, and sanitation use purposes and does not include an unfinished basement, attic, unenclosed porch, garage, carport, utility room, or storage room. (Also see Floor Area, Gross.)

Loading Space, Off-Street: An unobstructed area within, adjacent to, or on the same site of non-residential use building provided and maintained for the temporary parking of trucks and other commercial delivery vehicles for the purposes of loading and unloading goods, wares, materials, and merchandise.

Lot: A parcel of land of described legal boundary and area, per the types and terms defined as follows; (see illustration).

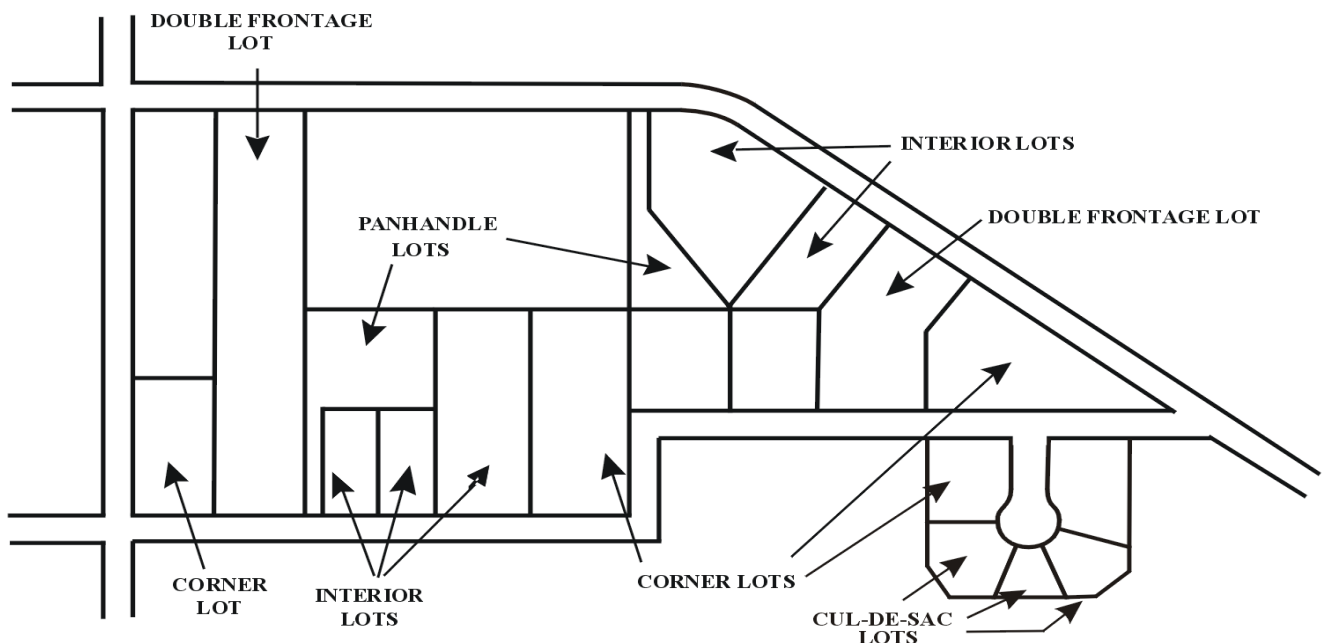

Lot, Building or Buildable: A lot of record which meets or otherwise satisfies permit requirements of this Code in effect at the time of its creation for construction or placement of one or more buildings and accessory structures (Also see Lot of Record, Legal Non-Conforming and Grandfathered.)

Lot, Corner: A lot bordered by public roads/streets along two (2) or more of its intersecting boundaries.

Lot Coverage: The percentage of a lot of surface covered by structures and pavement, or other impervious material.

Lot Depth: The mean horizontal distance between the front and rear lot lines measured in the mean direction of the side lot lines.

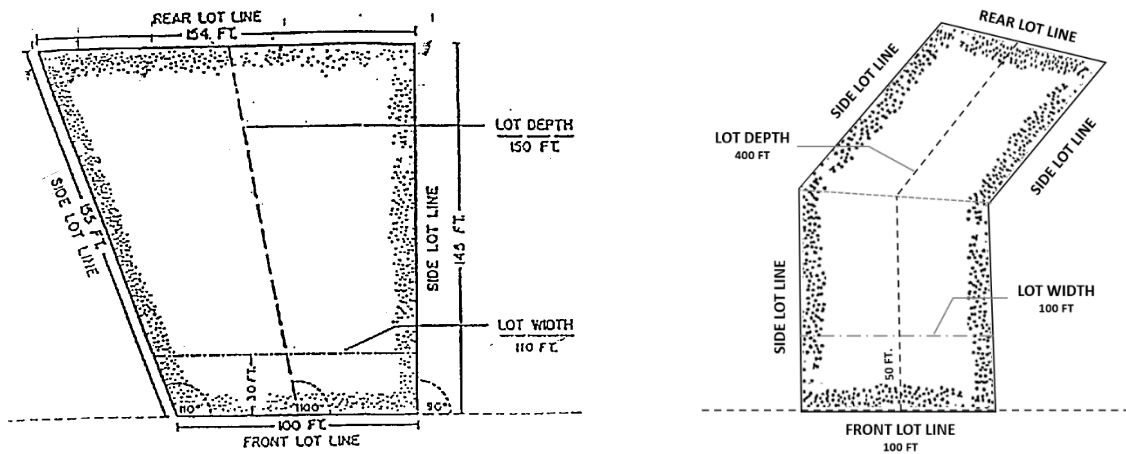

Lot, Double Frontage: A lot having frontage along two (2) public roads/streets at opposite ends of the lot.

Lot, Single Frontage: A lot having frontage along one (1) public road/street.

Lot, Panhandle (a.k.a. Flag Lot) as named due to shape: A lot along which the only legal road/street frontage is at one end of a narrow strip of land which extends back from the road/street to the body portion of the lot.

Lot Frontage: Any boundary of a lot in common with the right-of-way (or roadway easement) line of a public road/street that is along that boundary, as established by the County Thoroughfare Plan.

Lot Lines: The intersecting lines which form the legal boundary of the lot, as surveyed or recorded (see illustration).

Lot Line, Front: The boundary line(s) of a lot which, respectively, coincide with the public road/street right-of-way line(s), or the road/street centerline(s) as applicable if there is no right-of-way line. On a panhandle lot, it is the next closest line back from and mostly parallel with the front line at the road/street. All lot lines along streets are front lot lines.

Lot Line, Rear: The boundary line of a lot that is opposite and usually most distant from and often nearly parallel to the front lot line. On corner lots and a pie-shaped lot where the side lot lines come to a point at the rear of the lot, there is no rear line.

Lot Line, Side: The boundary line of a lot, which, respectively, extend between each end of the front and rear boundary lines. Or, front the opposite ends of the front line to intersect each other at the rear-most point of a pie-shaped lot.

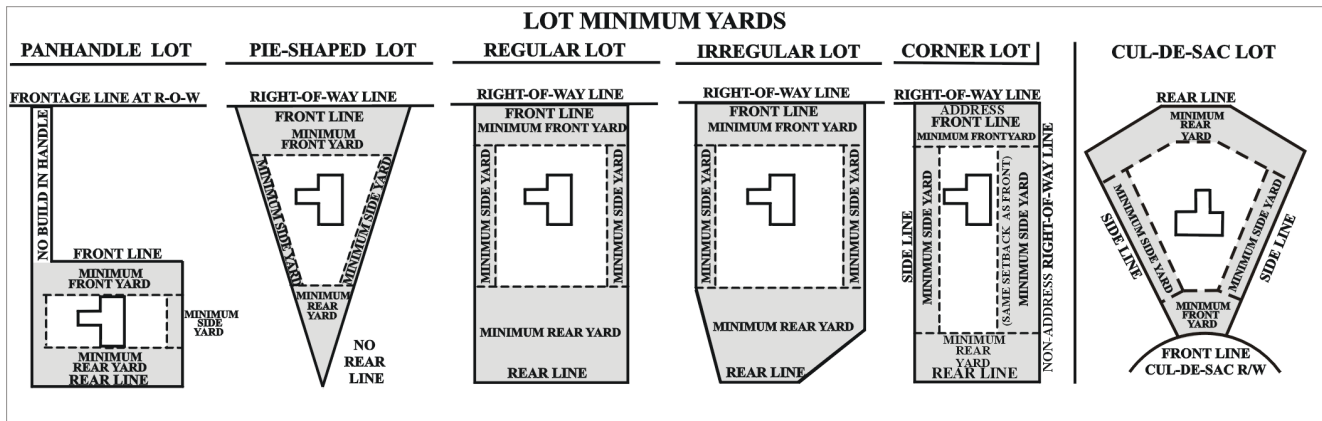

Lot, Non-Building or Unbuildable: A lot that does not meet the requirements of the current Zoning Code or the Zoning Code in effect at the time of its creation.

Lot of Record: A lot that met the requirements of the Zoning Code that was in effect at the time of its creation (See also non-conforming).

Lot Width: The distance between the side lot lines, that is function of the lots Maximum Lot Depth to Width Ratio.

Lowest Floor: The lowest floor of the lowest enclosed area in a building, including basement. (Also see Lowest Habitable Floor.)

Lowest Habitable Floor: The elevation of the lowest floor area of a building which is deemed habitable space certified by the Chief Building Official of Warren County, Ohio, being above the minimum elevation required by the Warren County Flood Damage & Prevention Regulations if applicable to the building being within one hundred (100) year floodplain. (Also see Lowest Floor.)

Luminaire (aka Light Fixture): A complete lighting unit, consisting of a light source and all mechanical, electrical, and decorative parts.

Major Subdivision: The division of a parcel of land that requires the approval of plat by the Regional Planning Commission as authorized by Section 711 of the Ohio Revised Code.

Manufacturing: To bring something into being by forming, shaping, combining, or altering materials. (See Industrial)

Manufactured Home: A building unit or assembly of closed construction that is fabricated in an off-site facility and constructed in conformance with the federal construction and safety standards established by the Secretary of Housing and Urban Development pursuant to the "Manufactured Housing Construction and Safety Standards Act of 1974," 88 Stat. 700, 42 U.S.C.A. 5401, 5403, and that has a permanent label or tag affixed to it, as specified in 42 U.S.C.A. 5415, certifying compliance with all applicable federal construction and safety standards. (ORC 3781.06)

Manufactured Home, Permanently Sited: Means a manufactured home that meets all of the following criteria:

- (a) The structure is affixed to a permanent foundation and is connected to appropriate facilities;
- (b) The structure, excluding any addition, has a width of at least twenty-two (22) feet at one point, a

length of at least twenty-two (22) feet at one point, and a total living area, excluding garages, porches, or attachments, of at least nine hundred (900) square feet;

- (c) The structure has a minimum 3:12 residential roof pitch, conventional residential siding, and a six (6) inch minimum eave overhang, including appropriate guttering;
- (d) The structure was manufactured after January 1, 1995;
- (e) The structure is not located in a manufactured home park as defined by section 3733.01 of the Revised Code.

Massage Parlor: Any place where, for any form of consideration or gratuity, massage, alcohol rub, administration of fomentations, electric or magnetic treatments, or any other treatment or manipulation of the human body occurs as a part of, or in connection with, “specified sexual activities”, or where any person providing such treatment, manipulation, or service related thereto, exposes his or her “specified anatomical areas”. This definition does not include the practice of massage in a licensed hospital under the auspices of a hospital by a licensed physician, surgeon, chiropractor, or osteopath, by any nurse or technician working under the supervision of a licensed physician, surgeon, chiropractor, or osteopath, or by trainers for any amateur, semi-professional, professional athlete, or athletic team, or school athletic program.

Materials/Resource Recovery Facility (MRF): A facility that extracts, removes, or reclaims valuable materials and/or energy from solid wastes or any combination of structures, machinery, or devices utilized to separate, process, modify, convert, treat, or prepare collected solid waste for management other than by disposal so that component materials or substances or recoverable resources may be recovered or used as a new material or energy resource. For purpose of this Zoning Code, an MRF is also further defined to mean an engineered complex constituted by one (1) or more building(s) or completely contained installation(s) consisting of structures, machinery and/or devices that are utilized to separate, process, modify, convert, treat, or prepare incoming solid waste for purpose of extracting, recovering, removing, or reclaiming one (1) or more component material, substance, or resource for reuse.

Maximum Lot Depth to Width Ratio: The length of a lot that does not exceed the lot width as established within a defined ration.

Micro Wind System: A building-mounted WECS that has a nameplate capacity (manufacturer’s rating) of ten (10) kilowatts or less, and projects no more than fifteen (15) feet above the highest point of the roof. These WECS are designed primarily to reduce on-site consumption of electrical power.

Mineral Extraction Operation: Mineral Extraction Operation shall be defined the same as “operation” or “surface mining operation”. “Operation” or “surface mining operation” means all of the premises, facilities, and equipment used in the process of removing minerals, or minerals and incidental coal, by surface mining from a mining area in the creation of which mining area overburden or minerals, or minerals and incidental coal, are disturbed or removed, such surface mining area being located upon a single tract of land or upon two (2) or more contiguous tracts of land. Separation by a stream or roadway shall not preclude the tracts from being considered contiguous. (ORC 1514.01(F) (1))

Minimum Lot Size: The smallest allowable portion of a parcel determined to be usable for the proposed construction of facilities, according to applicable development standards. The size of the lot shall be computed exclusive of any portion of the right-of-way of any public or private street or easement of access; approved stormwater draining retention or detention ponds; and utility easements beyond the public utility easement.

Minimum Lot Width: The distance between the side lot lines, measured at the minimum front building setback line.

Minimum Opening Elevation (MOE): The elevation of the lowest opening through a building foundation wall or the lowest floor of a building at which a door (including a walkout basement), window, window well, or other opening is permitted, as calculated and proposed on a construction grading plan, Zoning/Building Permit plot plan, or recorded subdivision by an engineer registered in the State of Ohio, and verified by the Warren County Engineer. (Also see Lowest Habitable Floor.)

Minor Subdivision or lot Split: A division of a parcel of land that does not involve the approval of a plat by the Regional Planning Commission as authorized by Section 711.131, Ohio Revised Code.

Mobile Home: A building unit or assembly of closed construction that is fabricated in an off-site facility, is more than thirty five (35) body feet in length or, when erected on-site, is three hundred twenty (320) or more square feet, is built on a permanent chassis, is transportable in one (1) or more sections, and does not qualify as a manufactured home as defined in division (C)(4) of section 3781.06 of the Revised Code or as an industrialized unit as defined in division (C)(3) of section 3781.06 of the Revised Code. (ORC 4501.01 (O))

Motel: A commercial use of land and the building or group of buildings in which lodging and perhaps boarding is offered to transient guests for compensation, with access to each unit through an exterior door, typically in close proximity to parking (also see Hotel).

Motor Home: (See Recreational Vehicle)

Motor Vehicle: Any self-propelled vehicle designed primarily for transportation of persons or goods along public streets or alleys, or other public ways.

Natural Succession: The gradual and continuous replacement of one kind of plant and animal group by a more complex group that naturally succeeds the previous group. The plants and animals present in the initial group modify the environment through their life activities thereby making it unfavorable for themselves. They are gradually replaced by a different group of plants and animals better adapted to the new environment.

Non-Conforming: The use of any dwelling, building, or structure and of any land or premises that does not meet the current regulations of this zoning code

Non-Conforming, Legal: (See Legal Non-Conforming)

Nude or Seminude Model Studio:

- (a) “Nude or semi-nude model studio” means any place where a person, who regularly appears in a state of nudity or semi-nudity, is provided for money or any other form of consideration to be observed, sketched, drawn, painted, sculptured, photographed, or similarly depicted by other persons.
- (b) A modeling class or studio is not a nude or semi-nude model studio and is not subject to this chapter if it is operated in any of the following ways:
 - (1) By a college or university supported entirely or partly by taxation;
 - (2) By a private college or university that maintains and operates educational programs, the credits for which are transferable to a college or university supported entirely or partly by taxation;
 - (3) In a structure that has no sign visible from the exterior of the structure and no other advertising indicating that a person appearing in a state of nudity or semi-nudity is available for viewing, if in order to participate in a class in the structure, a student

must enroll at least three (3) days in advance of the class and if not more than one nude or semi-nude model is on the premises at any one time.

Nudity, nude, state of nudity: (ORC 2907.01) Means the showing, representation, or depiction of human male or female genitals, pubic area, or buttocks with less than a full, opaque covering, or of a female breast with less than a full, opaque covering of any portion thereof below the top of the nipple, or of covered male genitals in a discernibly turgid state.

Nuisance: A condition, activity, or situation (such as a foul odor, or intrusive lighting) that interferes with the use or enjoyment of property, especially, a non-transitory condition or persistent activity that either injures the physical condition of adjacent land or interferes with its use or with the enjoyment of easements on the land or of public highways.

Nursery: An agricultural operation, including land, buildings and/or structures for the cultivating, harvesting, storage, and wholesale or retail sale of plants, flowers, shrubbery, or trees grown on-site. Sales of accessory, gardening, or landscaping materials not grown on-site do not qualify as agricultural.

Nursing Home: (See Institutional Care Facility as a type of Community-Based Residential Social Service Facilities)

Official Thoroughfare Plan, Warren County, Ohio: The document establishing the functional classification of the roads/streets which comprise the Warren County thoroughfare network, the width of right-of-way required for the roads/streets in each class, and the projected locations for potential future roads/streets.

Office: A use of land and building(s) for an administrative, professional service, governmental, institutional, or semi-public use activity or operation.

Office/Warehouse: A use of land and building(s) for an administrative office in conjunction with a warehouse business. A showroom is permitted.

Ohio Rapid Assessment Method: A multi-parameter qualitative index established by the Ohio Environmental Protection Agency (OEPA) to evaluate wetland quality and function.

Open Space: All or part of one (1) or more parcels of land, of public or private ownership, existing, improved, and/or set aside, dedicated, designated, or reserved for recreational, resource protection, amenity, and/or buffering use purposes, but not including road/street rights-of-way.

Open Space, Active: Open space designed to be improved and set aside, dedicated, designated or reserved for recreational facilities, including, but not limited to, swimming pools, or fishing ponds, lakes, play equipment for children, ball fields, court games, picnic facilities, alternative pedestrian circulation systems, etc., areas shall be determined to be sufficient in size and shape to be potentially useable. Designated flood plain, stormwater retention basins or ponds and stormwater detention basins greater than three-fourths (3/4) acre in size designed to be utilized for active recreational purposes shall qualify provided a perpetual mechanism has been established for maintaining and ensuring such area; however, in no event shall the following qualify as active open space:

- (a) Areas sloped greater than fifteen (15) percent.
- (b) Completely wooded areas not incorporating pedestrian circulation systems or other active recreational facilities.
- (c) Normally required sidewalks outside open space areas.

Open Space, Common: Is an area or areas within the boundaries of the PUD designed, set aside, and maintained for use by residents of the PUD that is not dedicated as public lands and does not include open space as defined. Common open space includes swimming pool, golf courses, club houses, tennis

courts, playing fields, land to accommodate required green infrastructure such as planting strips, street medians/islands, and conventional stormwater management devices.

Open Space, Passive: Open space designed to be essentially unimproved and set aside, dedicated, designated, or reserved for peaceful aesthetic enjoyment.

Open Space, Primary: The following are primary open space areas: The one hundred (100) year floodplain; stream buffer areas; wetlands; habitat for federally listed endangered or threatened species; archeological sites, important historic sites; cemeteries; and burial grounds.

Open Space, Secondary: The following are secondary open space areas and shall be included within the required open space to the maximum extent possible: native forests of at least one contiguous acre; other significant natural features; areas that connect the tract to neighboring open space, trails or greenways; soils with severe limitations for development due to drainage problems; agricultural lands of at least fifteen (15) contiguous acres.

Ordinary High Water Mark: The point on the bank or shore of a stream to which the presence and action of surface water is so continuous as to leave a distinct marking by erosion, destruction, or prevention of woody terrestrial vegetation, a predominance of aquatic vegetation or other easily recognized characteristic. The ordinary high-water mark defines the channel of a stream.

OSHA: The Occupational Safety and Health Act, 29 U.S.C. 651 et seq.

Outdoor Amphitheater: A place, not enclosed in a building, having a stage and seating for performances, concerts, and the like, with the seating for spectators arranged largely within a natural or artificial grade in the land, such as a hillside or depression.

Owner Occupant: The occupant of a residential dwelling owned by the same.

Parcel: A contiguous tract of land in one possession (see Lot).

Parcel, Parent: A parcel which existed as of *January 20, 2012* of this Zoning Code.

Park, Trailer: (See Recreational Vehicle):

Parking Lot: A portion of a parcel of land devoted to unenclosed parking spaces.

Parking Space: An area of a parking lot designated for the parking of a single motor vehicle (see parking lot and parking space, handicapped).

Parking Space, Handicapped: A parking space sized and maintained with permanent signage and markings for use by the handicapped, in conformance with the requirements of the Americans With Disabilities Act (Public Law 101-336), as amended.

Pavement, Permeable: Pavement materials such as pervious concrete, porous asphalt, interlocking concrete pavers, bricks, or similar material (excluding gravel) which allows storm water to percolate through, rather than runoff (see Runoff).

Parking Bay: Two adjacent rows of parking spaces.

Parking Row: A set of parking spaces aligned in a linear fashion within a parking lot.

Park, Trailer: (See Recreational Vehicle)

Personal Service: An establishment primarily engaged in providing individual services generally related to personal needs, such as, but not limited to barber shops, beauty shops, nail salons, day spas, travel agencies, and photographic studios.

Planned Unit Development (PUD): A land area zoned if approved as requested by the owner(s) or designated agent for unified development with flexible restrictions on residential, commercial, industrial, and/or public uses. As defined by (Black's Law Dictionary).

Plat: A map describing a piece of land and its features, such as boundaries with dimensions, lots, roads, and easements. Black's Law Dictionary

Potable Water: Water suitable for human consumption, as defined by SWDA.

Principle Permitted Use: The primary or predominant land use activity for which a building, structure or lot is to be used.

Protected Uses: Any public building owned, leased, or held by the United States, the State of Ohio, Warren County, any city, village, or township, any special district or school district, or any other agency or political subdivision which building is used for government purposes; or land which has been designated for park or recreational activities, including but not limited to: a park, playground, nature trails, swimming pool, reservoir, athletic field, basketball or tennis courts, pedestrian or bicycle paths, open space, wilderness areas, recreation area, or similar land; or quasi-public facility (i.e., any building or improved property customarily open to the public for non-commercial purposes, but which is not under government ownership or control); or religious institution (i.e., any church, synagogue, mosque, temple or building used primarily for religious worship and related religious activities); or residential district or use, as set forth in this Zoning Code; or school (i.e., any public or private educational facility, including, but not limited to, child care facilities, nursery schools, pre-schools, kindergartens, elementary, primary, intermediate, junior, middle, secondary, or high schools, vocational schools, continuation schools, special education schools, junior colleges, colleges and universities, but not including facilities used primarily for another purpose(s) and only incidentally used as a school).

Protected Public Water Supply: A public water system with at least fifteen (15) service connections used by year-round residents whose wells lie over the sole source aquifer.

Public: Anything owned and operated by the federal government, state government, or any political subdivision.

Quasi-Public: A non-governmental use, facility, structure, or service, performed by a non-profit corporation or institution of a religious, cultural, educational, philanthropic, or similar nature.

Raingardens: a shallow depression that is planted with native vegetation that temporarily stores and treats polluted rainwater from rooftops, parking lots, driveways, and walkways before entering nearby watersheds.

RCRA: The Resource Conservation and Recovery Act of 1976.

Re-compacted Soil Liner: Soil and perhaps other earthen material of suitable composition excavated from, or imported to, a land disposal site, deposited or from or imported to a land disposal site, deposited or laid in place in loose lifts where the prescribed waste is to be disposed and compacted per lift until a required depth in thickness and permeability of the liner is achieved, for the purpose of preventing or minimizing leachate infiltration into underlying undisturbed earth and ground water.

Recreation Active: Recreation requiring some constructed facilities and organized activities.

Recreation Camp: The same as in Ohio Revised Code, Sec. 3733.01 (G) or as may be amended in the future, is any tract of land upon which five (5) or more portable camping units are placed and includes any roadway, building, structure, vehicle, or enclosure used or intended for use as a part of the

facilities of the camp. A tract of land that is subdivided for lease or other contract of the individual lots is a recreation camp if five (5) or more portable camping units are placed on it for recreation, vacation, or business purposes. This does not include any tract of land used solely for the storage or display for sale of dependent recreational vehicles (defined in Sec. 3.361) or solely as a temporary park-camp (defined in Sec. 3.353).

Recreation Facility, Commercial: Recreation facilities operated as a business and open to the general public for a fee.

Recreation Facility, Private: Country clubs, riding stables, golf courses, and other private non-commercial recreation areas and facilities, or recreation centers including private swimming pools.

Recreation Facility, Public: Publicly owned or operated recreation facilities.

Recreation Park-Camp; Combined: The same as in Ohio Revised Code, Sec. 3733.01 (H), or as may be amended in the future, is any tract of land upon which a combination of five (5) or more self-contained recreational vehicles or portable camping units are placed and includes any roadway, building, structure, vehicle, or enclosure used or intended for use as part of the park facilities. A tract of land that is subdivided for lease or contract of the individual lots is a combined park-camp if a combination of five (5) or more recreational vehicles or portable camping units are placed on it for recreation, vacation, or business purposes. This definition does not include any tract of land used solely as a temporary park-camp (as defined in Sec. 3.353).

“Recreation park-camp: combined”: does not include any tract of land used solely as a temporary park-camp or solely as a manufactured home park.

Recreation Park-Camp; Temporary: The same as in Ohio Revised Code, Sec. 3733.01 (R), or as may be amended in the future, is any tract of land used for a period not to exceed a total of twenty-one (21) days per calendar year for the purpose of parking five (5) or more recreational vehicles, dependent recreational vehicles, or portable camping units, or any combination thereof, for one (1) or more periods of time that do not exceed seven (7) consecutive days or parts thereof.

Recreation Passive: Recreation that involves existing natural resources and has a minimal impact.

Recreational Vehicle (a.k.a. RV): A vehicular portable structure that:

Is designed for the sole purpose of recreational travel;

Is not used for the purpose of engaging in business for profit;

Is not used for the purpose of engaging in intrastate commerce;

Is not used for the purpose of commerce as defined in 49 C.F.R. 383.5, as amended;

Is not regulated by the public utilities commission pursuant to ORC Chapters 4919., 4921., or 4923; and,

Is classed as one of the following, per Ohio Revised Code (ORC) Sec. 4501.01 (Q).

(1) “Travel Trailer”: A non-self-propelled recreational vehicle that does not exceed an overall length of thirty-five (35) feet, exclusive of bumper and tongue or coupling, and contains less than three hundred twenty (320) square feet of space when erected on site. "Travel Trailer" includes a “tent-type fold-out camping trailer” as defined in Sec. 4517.01 of the Ohio Revised Code, or as may be amended in the future, which means any vehicle intended to be used, when stationary, as a temporary shelter with living and sleeping facilities, and, according to the following listed properties and limitations, has a minimum of twenty-five (25) percent of the fold-out portion of the top and sidewalls combined that must be constructed of canvas, vinyl, or other fabric, and form an integral part of the shelter, and when folded, the unit must not exceed fifteen (15) feet in length (exclusive of bumper and tongue), sixty (60) inches in height (from the point of contact with the ground), eight (8) feet in width, and one (1) ton gross weight at the time of sale.

(2) “Motor Home” is a self-propelled recreational vehicle that is constructed with permanently installed facilities for cold storage, cooking and consuming of food, and for sleeping.

(3) “Truck Camper” is a non-self-propelled recreational vehicle that does not have wheels for road use and is designed to be placed upon and attached to a motor vehicle. “Truck camper” does not include truck covers that consist of walls and a roof, but do not have floors and facilities enabling them to be used as a dwelling.

(4) “Fifth-Wheel Trailer” is a vehicle that is of such size and weight as to be movable without a special highway permit, that has a gross trailer area of four hundred (400) square feet or less, that is constructed with a raised forward section that allows a bi-level floor plan, and that is designed to be towed by a vehicle equipped with a fifth-wheel hitch ordinarily installed in the bed of a truck.

(5) “Park Trailer” is a vehicle that is commonly known as a park model recreational vehicle, meets the American National Standard Institute standard A119.5 (1988) for park trailers, is built on a single chassis, has a gross trailer area of four hundred (400) square feet or less when set up, is designed for seasonal or temporary living quarters, and may be connected to utilities necessary for the operation of installed features and appliances.

Recreational Vehicle; Dependent: Means a recreational vehicle other than a self-contained recreational vehicle. “Dependent recreational vehicle” includes a park model.

Recreational Vehicle; Self-Contained: Means a recreational vehicle that can operate independent of connections to sewer and water and has plumbing fixtures or appliances all of which are connected to sewage holding tanks located within the vehicle. “Self-contained recreational vehicle” includes a park model.

Recreational Vehicle (a.k.a. RV) Park: Means any tract of land used for parking five (5) or more self-contained recreational vehicles and includes any roadway, building, structure, vehicle, or enclosure used or intended for use as part of the park facilities and any tract of land that is subdivided for lease or other contract of the individual lots for the express or implied purpose of placing self-contained recreational vehicles for recreation, vacation, or business purposes. “Recreational vehicle park” does not include any tract of land used solely for the storage or display for sale of self-contained recreational vehicles, solely as a temporary park-camp, or solely as a manufactured home park.

Recycling: The process of collecting, sorting, cleansing, treating and reconstituting solid waste that would otherwise be disposed in a solid waste disposal facility and returning reconstituted materials to commerce as commodities for use or exchange, per Ohio Administrative Code Rule 3745-27-01 (WW).

Recycling Facility: An engineered facility or site where recycling is the primary objective of the facility, and:

(1) The facility accepts only source-separated material and/or mixed recyclables which are currently recoverable using existing technology; or,

(2) The facility accepts mixed solid waste streams, and recovers for beneficial use not less than 60 percent (60%) of the volume of solid wastes brought to the facility each month (as averaged monthly) for not less than eight (8) months in each calendar year: and disposes of not more than forty percent (40%) of the total volume of solid wastes brought to the facility each month (as averaged monthly) for not less than eight (8) months in each calendar year. Does not include a solid waste disposal facility and does not include a waste tire disposal facility.

Regularly features or regularly shown: Means a consistent or substantial course of conduct, such that the films or performances exhibited constitute a substantial portion of the films or performances offered as a part of the ongoing business of the adult entertainment establishment.(ORC 2907.39)

Regulated Substances:

- (A) Regulated Substances are chemicals or mixtures of chemicals that are health hazards. Materials packaged for personal or household use as food or drink for man or other animals are not Regulated Substances. Regulated Substances include:
- (1) Chemicals which are regulated by SDWA, TSCA, RCRA, OSHA, CERCLA, or other state and/or federal environmental laws and regulations, or for which there is scientific evidence that acute or chronic health effects may result from exposure including carcinogens, toxic and highly toxic agents, reproductive toxins, irritants, corrosives, sensitizers, hepatotoxins, the hematopoietic system, and agents which damage the lungs, skin, eyes or mucous membranes.
 - (2) Mixtures of chemicals which have been tested as a whole and have been determined to be a health hazard.
 - (3) Mixtures of chemicals which have not been tested as a whole but which contain any chemical which has been determined to be a health hazard and which comprises one percent (1%) or greater of the composition on a weight per unit weight basis, and mixtures of chemicals which include a carcinogen if the concentration of the carcinogen in the mixture is one-tenth percent (0.1%) or greater of the composition on a weight per unit weight basis.
 - (4) Ingredients of mixtures prepared within the Aquifer Protection "A-P" Overlay Area in cases where such ingredients are health hazards but comprise less than one-tenth (0.1) of one percent (1%) of the mixture (on a weight per unit weight basis), if carcinogenic; or if less than one percent (1%) of the mixture (on a weight per unit weight basis), if non-carcinogenic.
 - (5) Petroleum and non-solid petroleum derivatives (except non-PCB dielectric fluids).
- B. Determination of whether a material is a Regulated Substance can be made upon review of a Material Safety Data Sheet (MSDS). This should be available from the manufacturer, vendor, or distributor of the product. The most recent United States Environmental Protection Agency, Title III Lists of Lists, is a reference to potential Regulated Substances and is not a comprehensive listing.
- C. Determination and verification of Regulated Substances shall be administered by the Warren County Zoning Inspector or his designee.

Religious Institution: A use of land and buildings located thereon for uses where persons regularly assemble, for religious purposes and related social and educational events, maintained and controlled by a religious body organized to sustain such ceremonies and activities (e.g., rectory, convent, parochial school, meeting hall, offices, outdoor worship facilities, child care).

Replacement Cost: The cost to replace a structure, damaged or destroyed, as determined by a written appraisal from a state certified appraiser.

Residential: A category of use inclusive of the land and building(s) and other structure(s) located thereon as a place utilized for dwelling purposes as specified and regulated in this code.

Restaurant: A business use where food and beverages are sold, prepared, served, consumed, and/or carried out.

Rest Home: (See Institutional Care Facility as a type of Community-Based Residential Social Service Facility)

Retail Small Scale/Light Manufacturing: Means an accessory and associated light manufacturing use conducted in conjunction with the primary retail use. The manufacturing use is conducted within the building in which the retail use is carried out, and the manufactured products are display and are available for sale on-site.

Right-of-Way: Land owned or purchased by or dedicated to the public for use as a public way, most often for purpose of containing a road or street. (see, Road and Street)

Road: A public way consisting of one (1) or more paved lanes providing for motor vehicle travel, perhaps parking, and providing frontage and access for abutting properties. (see Street and Thoroughfare)

Runoff: The portion of precipitation in excess of the infiltration capacity of underlying soils to absorb and contain which drains away from, and runs off, the surface of land. (See Impervious Surface)

Sand and Gravel Pit: An excavation resulting from a mining operation where the removal of sand and/or gravel is undertaken for commercial sale or use in another location, but does not include such excavation resulting from construction of a sanitary landfill.

Sandstone Quarry: An excavation resulting from a mining operation where the removal of sandstone is the principal material excavated for commercial sale or use in another location, but does not include such excavation resulting from construction of a sanitary landfill.

Sanitary Land filling: A method of disposing of solid wastes on land in a manner intended to minimize environmental hazards by compacting the solid wastes to the smallest practical volume, and apply cover material daily.

Sanitary Landfill Facility: An engineered facility where the final deposition of solid waste on or into the ground is practiced in accordance with Ohio Administrative Code (OAC) Chapters 3754-27 and 3754-37, including areas of solid waste placement, all groundwater monitoring/control system structures, buildings, explosive gas monitoring/control/extraction system structures, run-on and run-off control structures, sedimentation pond(s), liner systems, leachate management system structures and areas within the three hundred (300) foot radius, from the limits of solid waste placement unless deemed acceptable by the Ohio Environmental Protection Agency (OEPA).

Small Solar Facility: Pursuant to ORC 303.213 (A) (2), “Small Solar Facility” means solar panels and associated facilities with a single interconnection to the electrical grid and designed for, or capable of, operation at an aggregate capacity of less than 50 MW.

Solar Energy: means radiant energy (direct, diffused, or reflected) received from the sun that can be collected and converted into thermal or electrical energy.

Solar, Community: Also known as shared solar, or solar gardens, is an energy model that allows customers to buy or lease part of a larger off-site shared solar photovoltaic (PV) system. For the purposes of the Warren County Rural Zoning Code, “Community Solar” is a “Principal Solar Energy Production Facility”.

Solar Energy, Accessory: A solar collection system consisting of one or more roof mounted, ground/pole mounted, and/or building mounted/other structure mounted solar collector devices and solar related equipment and is intended to primarily reduce on-site consumption of utility power. A system is considered an accessory solar energy system only if it produces 120% or less of the onsite usage of electrical or thermal power. When a property upon which the system is installed also receives electrical power supplied by a utility company, excess electrical power generated and not presently needed for on-site use may be used by the utility company.

Solar Energy Equipment: Items for the purpose of generation, transmission, and storage of electricity, including but not limited to a solar photovoltaic cell, solar panels, lines, pumps, inverter(s), batteries, mounting brackets, racking, framing and/or foundation used for or intended to be used for the collection of solar energy.

Solar Energy System: means a system and associated facilities that collect Solar Energy, which may include, but is not limited to, a Roof/Building Mounted, Ground/Pole Mounted, or Other structure mounted / Integrated Energy System.

Solar Photovoltaic (PV): The technology that uses a semiconductor to convert light directly into electricity.

Solar, Ground/Pole Mounted Energy Systems: means a solar energy system that mounts a solar panel or panels and facilities on or above the ground.

Solar, Building Mounted/Other structure mounted/Integrated Energy Systems: means a solar energy system that is mounted to a structure in any way previously not defined or incorporated into or replaces standard building materials and does not have mounting equipment. For example, these systems may include materials that replace traditional roofing, shingle, or siding materials, awnings, canopies, skylights, or windows. This use includes parking lot solar canopies.

Solar, Participating Parcels: A parcel of land that participates by ownership, lease or easement agreement or by contractual agreement, with a person or entity conducting a Solar Energy System project.

Solar, Principal Energy Production Facility: An area of land or other area used for a solar collection system mainly used to capture solar energy and convert it to electrical energy. These production facilities primarily produce electricity to be used off-site. Principal solar energy production facilities consist of one or more roof mounted, ground/pole mounted, and/or building mounted/other structure mounted / integrated solar collector devices, solar related equipment, and other accessory structures and buildings including light reflectors, concentrators, and heat exchangers, substations, electrical infrastructure, transmission lines and other appurtenant structures and facilities. Examples include “Small Solar Facility” and “Community Solar Facility” as defined by statute or herein.

Solar, Roof Mounted Energy Systems: means a solar energy system that is mounted to a structure or building’s roof on racks

Screening: A method of shielding or obscuring abutting structures or uses by fencing, walls, berms, or densely planted vegetation.

Seat: For the purpose of determining the number of off-street parking spaces for certain uses, the space allocated for seating individuals, measuring not less than twenty four (24) lineal inches across the seating surface of a bench, pew, or space for loose chairs.

Secondary Dwelling Unit: An additional living unit that is associated with a primary dwelling unit, that is either located entirely within the principal structure of the primary dwelling unit or is a detached

accessory building, which serves as an additional living unit for sleeping, cooking, and sanitation, and that complies with the standards of Section 3.203.5. Secondary Dwelling Units are not for use and occupancy by tenants.

Semi-nude or State of Semi-nudity: Means a state of dress in which opaque clothing covers not more than the genitals, pubic region, and nipple of the female breast, as well as portions of the body covered by supporting straps or devices. (ORC §§ 503.51 & 2907.39)

Semi-public: (See Quasi-public)

Setback: The distance which a building or structure is set back inward from a street right-of-way line or parcel boundary line. (See Yards).

Setback Line, Front: The line inward and parallel from the front line of a lot representing the minimum distance which a principal building or structure is set back from that boundary (see illustration).

Setback Line, Rear: The line inward and parallel from a rear boundary line of a lot representing the minimum distance which a principal or accessory building is set back from that boundary (see illustration).

Setback Line, Side: The line(s) inward and parallel from a side boundary line(s) of a lot representing the minimum distance which a principal or accessory building is set back from that boundary (see illustration).

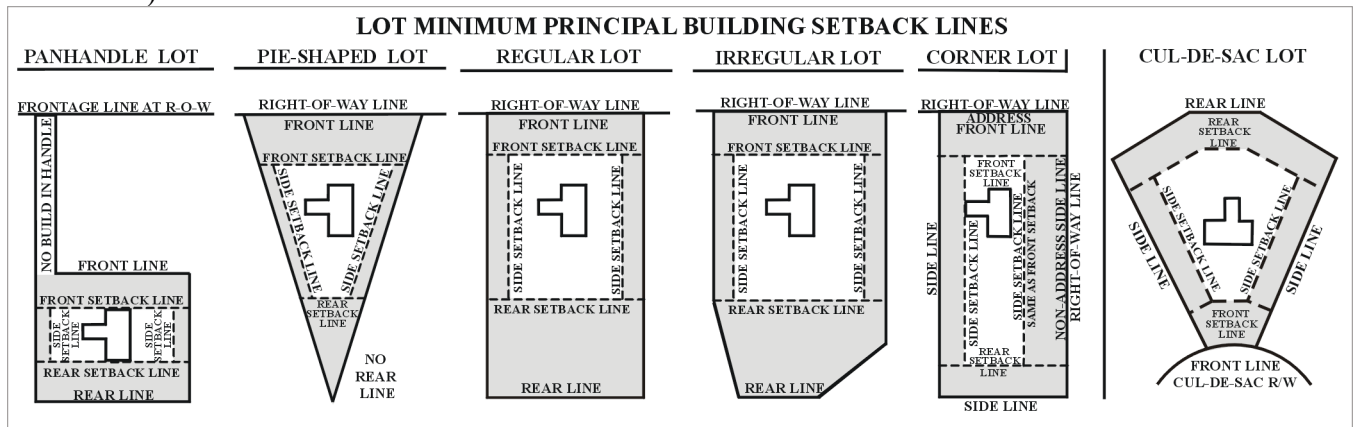

Sexual Encounter Establishment: (ORC §§ 503.51 & 2907.39)

- (a) “Sexual encounter establishment” means a business or commercial establishment that, as one (1) of its principal business purposes, offers for any form of consideration a place where either of the following occur:
 - (1) Two or more persons may congregate, associate, or consort for the purpose of engaging in specified sexual activities.
 - (2) Two or more persons appear nude or semi-nude for the purpose of displaying their nude or semi-nude bodies for their receipt of consideration or compensation in any type or form.
- (b) An establishment where a medical practitioner, psychologist, psychiatrist, or similar professional person licensed by the state engages in medically approved and recognized therapy, including, but not limited to, massage therapy, as regulated pursuant to section 4731.15 of the Revised Code, is not a “sexual encounter establishment.”

Sign: (a.k.a. Signage):

Means any structure, or natural object such as a tree, rock, bush, and the ground itself, or part thereof, or device attached thereto or painted or represented thereon, which shall be used to attract attention to any object, product, place, activity, person, institution, organization, or business, or which shall display or include any letter, word, banner, flag, pennant, insignia, device, or representation used as, or which is in the nature of, an announcement. For the purpose of these regulations, direction, or advertisement word “sign” does not include the American flag, the insignia of any government, governmental agency or of any charitable organization.

Sign, Abandoned: A sign which no longer identifies a bona fide business, lessor, service, owner, product, or activity, time of event passed, and where either of the following applies:

- (1) No legal owner can be found; or,
- (2) The property owner has been given a written order to rehabilitate or demolish, and for which work has not commenced and the owner can not demonstrate a diligent and good faith effort to implement actions; or,
- (3) The property taxes are delinquent and the site is not actively offered for sale, lease, or rent

Sign, Billboard: An Off-Premise sign that exceeds 6 feet in height or 48 square feet in area of a sign face and is freestanding sign supported by a single monopole structure.

Sign, Changeable Copy: A sign or a portion of a sign with letters, characters, or graphics that are not permanently affixed to the sign structure or face allowing the letters, characters, or graphics to be modified manually.

Sign, Channel Lettering: Fabricated or formed three-dimensional letter that may accommodate a light source or a sign where only the letters/logo is illuminated.

Sign, Channel Lettering-Reverse: A fabricated dimensional letter with opaque face and side walls with an internal light source to the rear of the letters used for “halo” or “silhouette” lighting.

Sign, Gateway: A sign announcing a development.

Sign, Ground: A sign solely supported on and from the ground.

Sign, LED: An LED sign is a sign or a portion of a sign with letters, characters, or graphics displayed on an LED board that may be modified to display a variety of messages.

Sign, Memorial or Memorial Tablet: A sign cut into a masonry or metal surface indicating the name of the structure (not the use of the structure) and/or the year of the structure's erection.

Signs, Non Conforming: Signs legally existing on the effective date of this code that does not conform to the height, size, and type provisions of this Chapter or the setback standards for the zoning district. For the purposes of this definition the term "sign" shall include the sign face and the structure on which the sign face is attached.

Sign, Off-Premise: A sign that directs attention to a business, commodity, service, or entertainment conducted, sold or offered at a location other than the premises on which the sign is located.

Sign, Permanent: All signs that are not temporary signs.

Sign, Pole: A sign solely supported on a pole.

Sign, Signature: A sign containing name and/or logo only.

Sign, Structure: The supports, uprights, bracing, or framework of any structure exhibiting a sign, be it single-faced, double-faced, or V-type or otherwise.

Sign, Temporary: A sign that is not designed or intended for display for more than thirty (30) days. Such signs are not permanently attached to a building, structure, or installed in ground. Temporary signs include but are not limited to pennants, banners, streamers, beacons, searchlights, and similar-type devices.

Sign, Wall: A sign painted on, attached to, or erected against an exterior wall of a building or other wall structure, with the display face of the sign parallel to and not more than twelve (12) inches from the wall and which does not project above the roof line or beyond the corner of a building on which mounted.

Sign, Window: A sign that is applied or attached to a window or door, or a sign located near a window within a building for the purpose of being visible to and read from the outside of the building

Site: Part or all of one (1) or more lot, parcel, or tract of land used, designed, intended, proposed or planned for specific use and development or a place where something was, is, or is to be located. (See Lot, Parcel and Use.)

Site Plan: A drawing of a property, to scale and with accurate dimensions, depicting the size and location of existing and proposed structures, building setbacks, rights-of-way, easements, walkways, and other such information.

Sleeping Room: A room within a residential dwelling that functions as a separate space used for living and sleeping, but not for cooking and eating purposes.

Slope: The degree of deviation of a surface from the horizontal, usually expressed in percent or degrees regarding the grade of land.

Small Wind Farm: A Wind Energy Conversion System (WECS) with a single interconnection to the electrical grid and designed for, or capable of, operation at an aggregate capacity of less than five (5) megawatts.

Soil: Natural deposited mineral and organic matter constituting the earth outer surface or as otherwise altered by man.

Solar Energy System: A device on a structure or a lot to collect, store, and use the energy from the sun.

Sole Source Aquifer: The southern portion of the Buried Valley Aquifer System of the Great and Little Miami River Basins of Southwestern Ohio, determined by the U.S. Environmental Protection Agency to be the sole or principal source of drinking water in Warren County, pursuant to Section 1424(a) or (e) of the Safe Drinking Water Act (SDWA) P.L. 95-523, as amended P.L. 96-502, 42 U.S.C. 300(f) et seq).

Solid Wastes: Such unwanted residual solid or semi-solid material as results from industrial, commercial, agricultural and community operations, excluding earth or agricultural and community operations, excluding earth or material from construction, mining, or demolition operations, or other waste materials of the type that would normally be included in demolition debris, non-toxic fly ash, spent non-toxic foundry sand and slag, and other substances that are not harmful or inimical to public health, and includes, but is not limited to, garbage, tires, combustible and non-combustible material, street dirt, and debris. Solid waste does not include any material that is an infectious waste or a hazardous waste.

Semi-solid material does not contain liquids which can be readily released under normal climatic conditions, as determined by Method 909 (Paint Filter Liquids Test) SW-846: "Test Methods for Evaluating Solid Wastes Physical/Chemical Methods".

Per recognition and allowance by the Ohio Environmental Protection Agency, residual waste as included herein is a type of solid waste and which may qualify as to characterization for disposal in certain classes of solid waste disposal facilities in conformance with Ohio Administrative Code Chapter 3745-30.

In accordance with Ohio Revised Code (ORC) Chapter 3734.027, low-level radioactive wastes are not included as a type of waste permissible for disposal at a solid waste disposal facility.

Asbestos waste handling and disposal is acknowledged as a type of waste permissible for disposal at a solid waste disposal facility in accordance with Ohio Administrative Code (OAC) Rules 3745-20-05 through 3745-20-07 inclusively, as amended.

"Infectious wastes" excluded from a solid waste disposal facility permissible by this Zoning Code are as defined in Ohio Administrative Code (OAC) Chapter 3734.01(R) inclusively, and as amended.

"Hazardous wastes" excluded from a solid waste disposal facility permissible by this Zoning Code are as defined in Ohio Administrative Code Chapter 3745-51, and as amended.

Solid Waste Disposal Facility: Any site, location, tract of land, installation, or building used for incineration, composting, sanitary land filling, or other methods of disposal of solid wastes.

Solid Waste Transfer Station: Any site, location, tract of land, installation, or building that is used or intended to be used primarily for the purpose of transferring solid wastes that are generated off the premises of the facility from vehicles or containers into other vehicles or containers for transportation to a solid waste disposal facility.

Specified Anatomical Areas: Used in the Zoning Code for the regulation of Sexually Oriented Businesses means and includes any of the following:

- (1) Less than completely and opaquely covered human genitals, pubic region, buttocks, anus, or female breast below a point immediately above the top of the areola; or,
- (2) Human male genitals in a discernibly turgid state even if completely and opaquely covered.

Specified Criminal Acts: The offenses defined in Ohio Revised Code Chapter 2907, as amended, and similar offenses pursuant to municipal ordinances, township/county resolutions of this or any other state, the statutes and regulations of any other state or of the United States, or tax violations in connection with Sexually Oriented Business.

Specified Sexual Activities: "Specified sexual activities" as used in the Zoning Code for the regulation of Sexually Oriented Businesses means and includes any of the following

- (1) The fondling, intentional touching of human genitals, pubic region, buttocks, anus, or female breast.
- (2) Sex acts, normal or perverted, actual or simulated, including intercourse, oral copulation, or sodomy; or,
- (3) Masturbation, actual or simulation; or,
- (4) Human genitals in a state of sexual stimulation, arousal, or tumescence; or
- (5) Excretory functions as part of, or in connection with, any of the activities set forth in subdivisions (1) through (4)

Stable: Building(s) and other structures and the land on which located used, designed, or intended for the boarding of domestic animals, most typically horses, including associated grazing, exercise, training, and show areas.

Stormwater Pollution Prevention Plan (SWPPP): The plan which describes all the elements of the stormwater strategy implemented during and after construction. The plan addresses erosion control and stormwater quality.

Stormwater Quality Treatment: The removal of pollutants from urban run-off and improvement of water quality, accomplished largely by deposition and utilizing the benefits of natural processes.

Story: The space in a building between the surface of one floor, other than a mezzanine, to that of the next floor above it or to the ceiling from the uppermost floor (See Basement).

Story, Half: A habitable space in a building above the highest full story below it and under a sloping roof of the building, if the line of intersection of the roof and wall is three (3) feet or less above its floor. (Also see Habitable Space.)

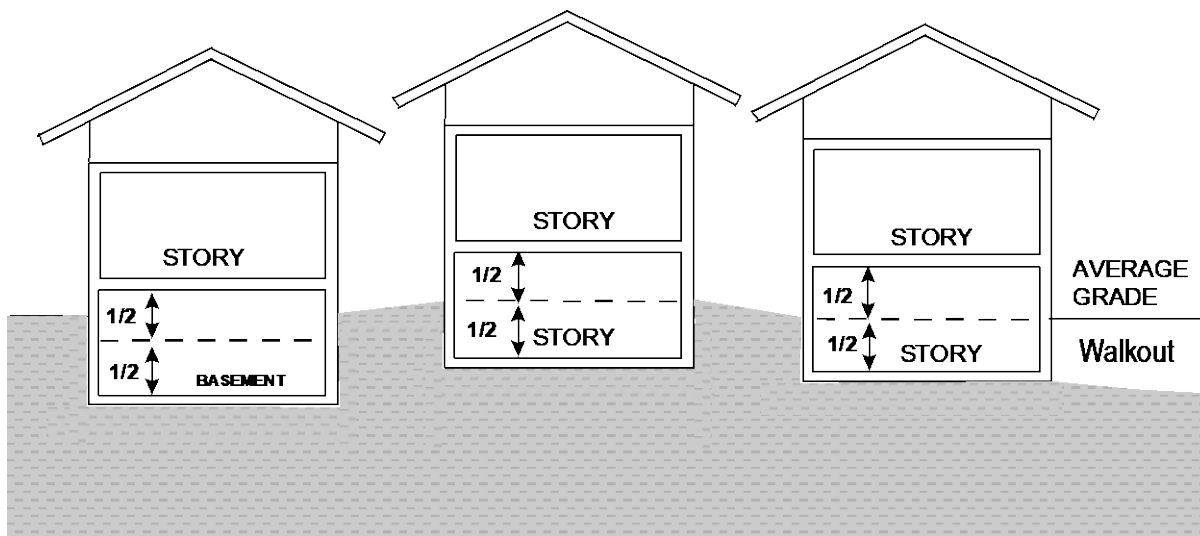

Stream: A surface watercourse with a well-defined bed and bank, either natural or artificial, which contains and conducts continuous or periodical flowing water in such a way that perennial terrestrial vegetation cannot establish roots within the channel.

Stream Setback: The distance set back from each bank of a stream to protect the stream setback area and stream from structural encroachment, impacts of development and streamside residents from impacts of flooding and land loss through erosion. Stream setbacks contain all land in between them to each side of the stream for which defined and required by the establishment criteria specified in this Section.

Stream Setback Area: A transitional area between flowing water and terrestrial ecosystems, which provides a continuous exchange of nutrients and woody debris between land and water. This area may or may not be periodically influenced by flooding, but often includes floodplain of the stream. Stream setback areas, if appropriately sized and managed, help to stabilize banks, limit erosion, reduce flood-size flows, and/or filter and settle out runoff pollutants, or perform other functions consistent with the purposes of this Section.

Street, Public: A public roadway constructed within the boundaries of an officially deeded and accepted public right-of-way or easement. Public roadways may be flanked by public utilities

easements, sidewalks, bikeways, curbs and gutters, side ditches. (See Warren County Thoroughfare Plan.)

Street, Private: Any road or street that is not publicly accepted, owned and maintained. These streets are used for access by the occupants of the development, their quest, and fire, emergency, public service, and public utility vehicles.

Structure: Anything constructed or erected, the use of which requires a permanent location on the ground or attached to something having a permanent location on the ground, including, but not limited to trailers or mobile homes, tents, signs, swimming pools, pergolas, kiosks, pilings, piers, and bulkheads, but not including septic tanks and septic systems; and accessory facilities associated with the provision of utilities such as drains, wells, transformers, and telephone poles.

Structure, Minor: Any small accessory structure or building such as birdhouses, tool houses, pet houses, play equipment, arbors, fire pits, outdoor cooking and grill islands, outdoor fireplaces, walls and fences, standalone generators, and electric vehicle charging units.

Subdivision: The division of a parcel of land, per Ohio Revised Code (ORC) Section 711.001 and the Warren County Subdivision Regulations (Also see Lot, Lot of Record, and Parcel.)

Structure, Temporary: A structure without a foundation or footing, to be removed upon the expiration of the permitting time frame.

Subdivision: The division of a parcel of land, per Ohio Revised Code (ORC) Section 711.001 and the Warren County Subdivision Regulations (Also see Lot, Lot of Record, and Parcel.)

Substantial Enlargement of a Sexually Oriented Business: An increase in the original floor area occupied by a sexually oriented business by more than 15 percent.

Suburban fringe: A transition zone between the city/villages and the rural area that are identified by the following zoning districts “R1-B”, “R2”, and “R3”.

Swimming Pool: A recreational use structure, above or in ground, containing water eighteen (18) inches or greater in depth, for purposes of swimming, wading, or bathing, inclusive of support facilities in relation thereto, such as enclosure fencing.

Telecommunications Facility: A FCC permitted wireless telecommunications facility that exists on or after October 31, 1996.

Telecommunications Facility, Base Station: Transmission equipment and any non-tower structure that facilitates FCC permitted wireless communications.

Telecommunications Facility, Collocation: The installation of additional transmission equipment on an existing tower or other permitted support structure.

Telecommunications Facility, Eligible Facilities Request: A request to modify an existing tower and/or base station that does not cause a substantial change to the physical dimensions of the tower or other support structure or base station, involving:

- (a) Collocating new transmission equipment;
- (b) Removing transmission equipment; or
- (c) Replacing transmission equipment.

Telecommunications Facility, Eligible Support Structure: A tower or other support structure that exists when a modification application is filed with the Warren County Zoning Inspector.

Telecommunications Facility, Equipment: Equipment that facilitates transmission and reception of FCC licensed or authorized wireless communication signals, including, but not limited to, antennas, coaxial or fiber-optic cable, radio transceivers, and regular and backup power supply.

Telecommunications Facility, Site: The area within the boundary of the leased or owned property that underlies and surrounds a telecommunications tower, or other support structure, and base station, and including, but not limited to any access driveway, utility service line, and fall-radius easements related to the facility.

Telecommunications Facility, Small Cell Tower: A tower greater than the zoning district height but under fifty (50) feet, or an existing facility that has been adapted for the location of transmission or related equipment to be used in the provision of Cellular Telecommunications Services. The term Small Cell Tower includes mini cell towers, distributed antenna system towers, micro cell towers, mini cell, or similar systems.

Telecommunications Facility, Substantial Change: Modifications to the physical dimensions of an eligible support structure that qualify according to the criteria specified in Section 3.205.11(N) (2).

Telecommunications Facility, Telecommunications Tower: A tower constructed for, or an existing facility that has been adapted for, the location of transmission or related equipment to be used in the provision of Cellular Telecommunications Services or Personal Communication Services. The use excludes Small Cell Towers.

Telecommunications Facility, Tower: A guy-wired, metal lattice, or monopole structure that is for the sole or primary purpose of supporting FCC permitted antennas and any associated equipment for facilitating wireless communication services.

Thermophilic Stage: A biological stage in the composting process characterized by a high rate of decomposition, large heat generation, and temperatures generally above one hundred (100) degrees Fahrenheit.

Thoroughfare Plan: The main or heavily traveled public roads, streets, or highways, identified by functional classification in the Warren County Official Thoroughfare Plan in being higher than Local in class. (See, Road, Street and Official Thoroughfare Plan).

Time of Travel Boundary: A locus of points from which water takes an equal amount of time to reach a given destination such as a well or wellfield.

Towers: Any free-standing or attached structure to a building or other structure; owned or principally used by a public utility or other person or entity that exceeds twice the permitted height requirement of the district.

Traffic Impact Study: A study which assesses the effects that a particular development's traffic will have on the transportation network. The report includes an analysis of anticipated roadway conditions, traffic circulation patterns and volumes. These studies are used to help evaluate whether the development is appropriate for a site and what type of transportation improvements may be necessary.

Travel Trailer: (See recreational vehicle)

Truck Camper: (See recreational vehicle)

Truck Terminal: A specialized distribution building for redistributing goods from one truck to another as an intermediate transfer point. These facilities are primarily used for staging loads (rather than long-term storage) and possess very little if any storage.

TSCA: The Toxic Substance Control Act, as amended, 15 U.S.C. 2601 et seq.

Underground Storage Tank: One or any combination of tanks, including the underground pipes connected thereto, that are used to contain an accumulation of regulated substances the volume of which, including the volume of the underground pipes connected thereto, is ten per cent or more beneath the surface of the ground. ORC_3737.87(P)

Use: The specific purpose for which land inclusive of the building(s) and other structure(s) thereon and the activities and operations thereof are utilized, designed, arranged, intended, occupied, or maintained.

Use, Temporary: A use permitted for a period of time specified per this code.

Utility Scale Wind Farm: Wind Energy Conversion System (WECS) installations with a total generating capacity over 5 megawatts which are subject to certification by the Ohio Power Siting Board.

Variance: A modification of the strict terms of this Code, if granted by the Board of Zoning Appeals (BZA).

Veterinary Animal Hospital or Clinic: A business use of land and structures thereon as a place used for the medical and surgical care, diagnosis, and treatment of animals, including grooming and boarding accommodations for treatment purposes of observation and recuperation.

Warehouse Depot: A use engaged in storage of manufactured products, supplies, and equipment. This uses is characterized by frequent trucking activity, open storage of material, but does not involve manufacturing, production or selling of the goods they handle.

Wastewater Disposal System, Central: (See Central Sanitary Sewage System)

Wastewater Disposal System, On-Site: A system for the purposes of storing, treating, and disposing of sewage and wastewater generated by the use on the site.

Water Pollution: The unpermitted release of sediment from disturbed areas, solid waste, leachate, or other contaminants into the waters of the state.

Water System, Central: A public system which provides water supply to a development, community, or region.

Water System, On-Site: A well or other similar installation on a site which provides a water supply for the uses on the site.

Waters of the State: All streams, lakes, ponds, marshes, watercourses, waterways, wells, springs, irrigation systems, drainage systems, and all other bodies or accumulations of water, surface and underground, natural or artificial, which are wholly or partly within, or border upon, the zoning jurisdiction, except those private waters which do not combine or affect a junction with natural surface or underground waters. (ORC 1509.01)

Wedding Facility, Event Center: A building or group of buildings where weddings; retreats; seminars; community events; private parties; and similar events are conducted in exchange for compensation. This use may include, but is not limited to, facilities for food preparation and serving, parking facilities, a caretaker residence, and administrative offices.

Well: A bored, drilled or driven-shaft, or a dug hole whose depth is greater than the largest surface dimension and whose purpose is to reach underground water or oil supplies, or to store or bury fluids below ground.

Wellhead: The physical structure, facility, or device at the land surface from, or through which, groundwater flows or is pumped from subsurface, water-bearing formations.

Well Field: A protected land area specified around a well head.

Wetlands: Those areas that are inundated or saturated by surface or groundwater at a frequency and duration sufficient to support, and that under normal circumstances do support, a prevalence of vegetation typically adapted for life in saturated soil conditions. Wetlands generally include swamps, marshes, bogs, fens, and similar areas, as defined by Soil & Water Conservation.

Wind Energy Conversion System: (WECS) means an aggregation of parts including the base, tower, generator, rotor, blades, supports, guy wires, and accessory equipment such as utility interconnections, battery banks, etc. in such a configuration as necessary to convert the power of wind into mechanical or electrical energy. WECS are also known as wind chargers, windmills, or wind turbines.

Wind Turbine: A machine that converts the wind's kinetic energy into rotary mechanical energy, which is then used to do work.

Yard: An open space, other than a courtyard, on the lot of a principal building, unoccupied by buildings or structures from the ground to the sky except by trees or shrubbery or as otherwise permitted per this Code. The depth of each required yard is measured between the setback line inward parallel from the lot line (see illustration).

Yard, Front: The yard extending the full width of the lot between the road/street right-of-way line at the front of the lot and the closest point of contact to the principal structure, with the minimum depth thereof measured from the right-of-way line established by the Warren County Official Thoroughfare Plan (see illustration).

Yard, Rear: The yard extending the full width of the lot between the closest distance from the rear lot line or rear-most point on a pie-shaped lot and the first point of contact by a principal structure (see illustration).

Yard, Side: The yard extending from the front yard to the rear yard (except in the case of a corner lot) between the closest point of contact by a principal structure and the nearest side lot line (see illustration) (also see Lot Line, Side).

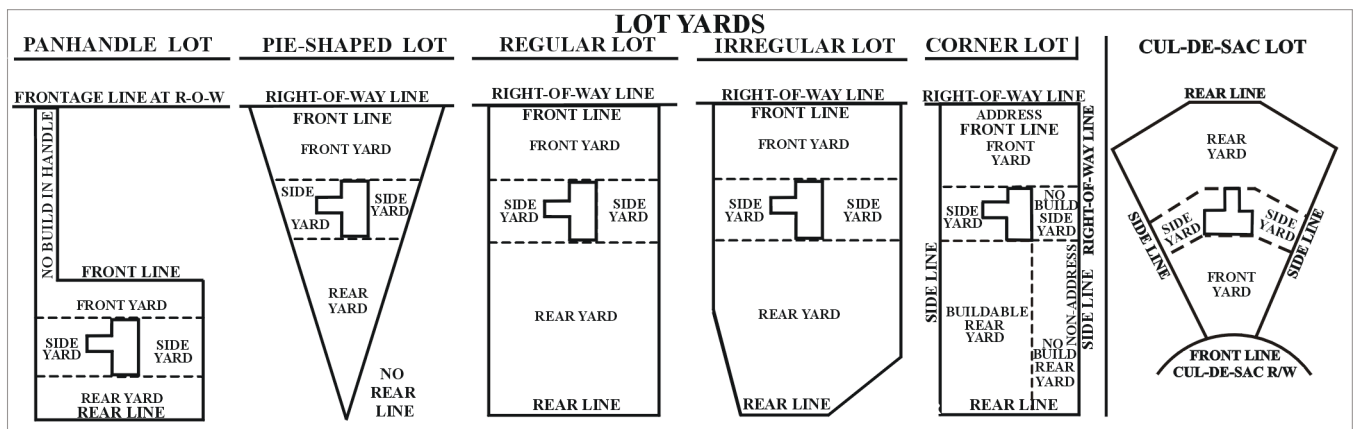

The right-of-way line is established by the Warren County Official Thoroughfare Plan.

Yard Waste: Leaves, branches, and limbs trimmed or pruned from trees and shrubs, lawn, or other vegetative ground cover, clippings, and garden waste.

Yard Waste Composting Facility: A composting facility receiving only yard wastes, animal wastes incidentally associated therewith, and bulking agents as defined herein.

Zoning District (a.k.a. Zone): An area designation for one of the several zoning classifications defined in this Code which is applied or may be requested for application to part or all of one (1) or more parcels of land, in specifying the permitting provisions, restrictions, and requirements for use of land and structures therein located. (See Zoning Overlay and Planned Unit Development.)

Zoning Inspector: Person(s) appointed by the Board of Warren County Commissioners to administer and enforce the Zoning Code.

Zoning Map, Official: The graphic depiction of the boundaries of the various Zoning Districts and Zoning Overlays which have been respectively applied in a uniform manner to all parcels of property under Warren County Zoning jurisdiction. (See § 2.102 of the Zoning Code.)

Zoning Overlay: A specific zoning area designation applied over the underlying zoning already applicable on part or all of one (1) or more parcel(s) which modifies the zoning regulations (See § 2.101 of the Zoning Code).

Zoning Permit: The official document issued by the Zoning Inspector that certifies that the use, development, and/or structures on a lot or parcel meet all permitting requirements of the Zoning Code.

Zoning Supplemental Regulations: Provisions, restrictions, and conditional requirements specified in the Zoning Code, which may be applicable in addition to the Zoning District and Zoning Overlay regulations.